

DIGITAL INSULATION TESTER
OPERATOR'S MANUAL

CONTENTS

1. SAFETY INFORMATION 1
1.1 PRELIMINARY 2
1.2 DURING USE 3
1.3 SYMBOLS 4
1.4 MAINTENANCE 5
2. DESCRIPTION 6
2.1 NAMES OF COMPONENTS 9
2.2 SWITCH AND BUTTONS ELUCIDATE 10
3. SPECIFICATIONS 11
3.1 GENERAL SPECIFICATIONS 11
3.2 ELECTRICAL SPECIFICATIONS 12
4. OPERATING INSTRUCTION 16

DIGITAL INSULATION TESTER

CONTENTS

4.1	SWITCH DISLOCATION ALARM 16
4.2	SOUND AND FLASH ALARM 16
4.3	READ HOLD 17
4.4	HAND OPERATING AND TIME MEASURING 17
4.5	PREPARATION FOR MEASUREMENT 18
4.6	MEASURING INSULATION RESISTANCE 19
4.7	MEASURING AC VOLTAGE 22
4.8	MEASURING DC VOLTAGE 24
4.9	MEASURING RESISTANCE 26
4.10	CONTINUITY TEST 27
5.	MAINTENANCE 29
5.1	BATTERY REPLACEMENT 29
5.2	TEST LEADS AND TEST CLIPS REPLACEMENT 30
6.	ACCESSORIES 31

1. SAFETY INFORMATION

This meter has been designed in general to comply with IEC 348 and according to IEC-1010 concerning about electronic measuring instruments with an overvoltage category (1000V CAT II, 600V CAT III) and pollution 2. Follow all safety and operating instructions to ensure that the meter is used safely and is kept in good operating condition.

Pay attention to cautions and warnings, which will inform you of potentially dangerous procedures.

 WARNING

To ensure safe operation, please follow the directions in this section carefully.

Electricity can cause severe injuries even with low voltages or currents. Therefore it is extremely important that you read the following information before using this Insulation Tester.

1.1 PRELIMINARY

1.1.1 When using the meter, the user must observe all normal safety rules concerning:

- Protection against the dangers of electrical current
- Protection of the meter against misuse

1.1.2 When the meter is delivered, check that it has not been damaged in transit.

1.1.3 When poor condition under harsh preservation or shipping conditions caused, inspect and confirm this meter without delay.

1.1.4 test leads or test clips must be in good condition. Before using verify that the insulation on test leads or test clips is not damaged and/or the leads wire is not exposed.

1.1.5 Full compliance with safety standards can be guaranteed only if used with test leads or test clips supplied. If necessary, they must be

replaced with the same model or same electric ratings.

1.1.6 This meter must only be used by a competent trained person and in strict accordance with the operator's manual.

1.2 DURING USE

1.2.1 Never exceed the protection limit values indicated in specifications for each range of measurement.

1.2.2 When the meter is linked to a measurement circuit, do not touch unused terminals.





1.2.3 Do not measure voltage if the voltage on the terminals exceeds 1000V above earth ground.

1.2.4 Always be careful when working with voltages above 60V DC or 30V AC rms, keep fingers behind the probe barriers while measuring.

1.2.5 Never connect the meter leads across on live circuits while the function switch is in the insulation resistance, resistance or continuity mode.

- 1.2.6 Ensure all circuits are de-energized before measuring.
- 1.2.7 Before rotating the range switch to change ranges, disconnect test leads from the circuit under test.
- 1.2.8 If any faults or abnormalities are observed, the meter can not be used any more and it has to be checked out.
- 1.2.9 Never use the meter unless the rear case is in place and fastened fully.
- 1.2.10 Please do not store or use meter in areas exposed to direct sunlight, high temperature, humidity or condensation.

1.3 SYMBOLS

-  Important safety information, refer to the operating manual.
-  Double insulation (Protection classII) .
-  Earth ground
-  Low Battery
- ~ AC (alternating current)

- ⎓ DC (direct current)
- Continuity Buzzer

1.4 MAINTENANCE

- 1.4.1 Please do not attempt to adjust or repair the meter by removing the rear case while voltage is being applied. A technician who fully understands danger involved should only carry out such actions.
- 1.4.2 Before opening the battery cover of the meter, always disconnect test leads or test clips from all sources of electric current.
- 1.4.3 Always set the function switch to the OFF position when the meter is not in use.
- 1.4.4 If the meter is to be stored for a long period of time, the batteries should be removed to prevent damage to the unit.
- 1.4.5 Do not use abrasives or solvents on the meter, use a damp cloth and mild detergent only.

2. DESCRIPTION

- This meter has the function of sound and flash alarm. If the function switch and range switch is out of place, you will hear a humming sound per two seconds from the inside alarming system. This protection provides for meter to avoid damage by operation improperly.
- In measurement, the test button is pressed, the meter's

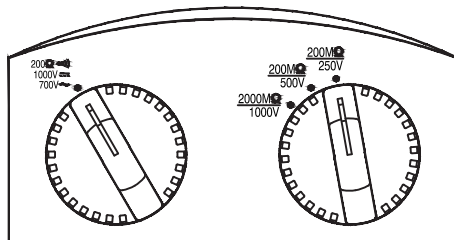

Fig 1

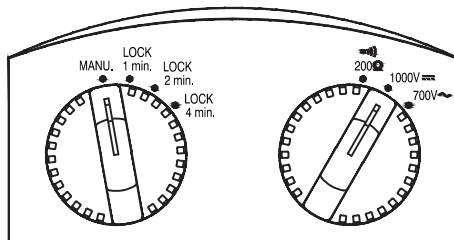

Fig 2

- alarming system will give out a humming sound (per two seconds), and the red high voltage output indicator is flashing, which warns the operator to pay attention to the high output voltage, and avoid getting electric shock.
- Overload protection and low battery indication is provided.
 - This meter is a portable professional measuring instrument with large LCD.
 - This meter has function of data hold.
 - When using, it can show ranges engineering unit enunciators measuring results.
 - A double rotary switch is used to select functions and ranges.
 - Test button with lock function.
 - Releasing the test button automatically will discharge the capacitance of a circuit under test.

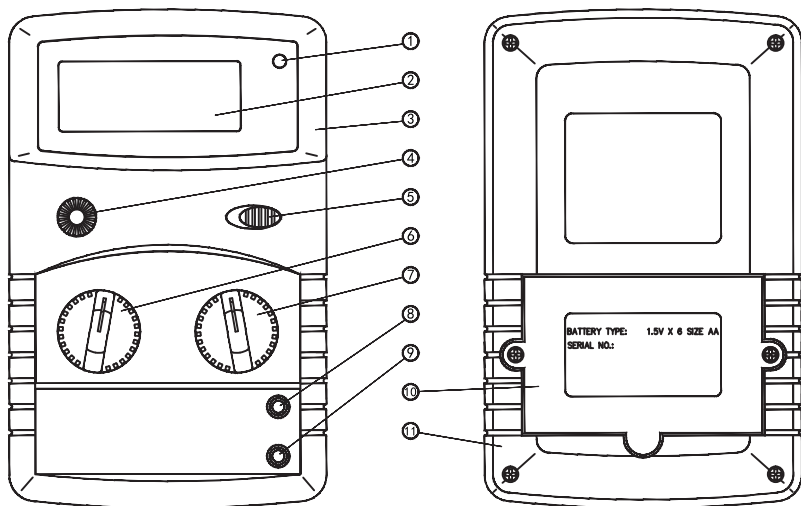

Fig 3

2.1 NAMES OF COMPONENTS (See Fig 3)

- ① High Voltage Output Indicator
- ② LCD Display
- ③ Panel
- ④ Test Button
- ⑤ Data Hold Switch (D-H)
- ⑥ Function Switch
- ⑦ Range Switch
- ⑧ HIGH Jack
- ⑨ LOW Jack
- ⑩ Battery Cover
- ⑪ Case

2.2 SWITCH AND BUTTONS ELUCIDATE

- Function Switch

This switch is used to select measure mode and the switch of power.

- Range Switch

This switch is used to select desired ranges.

- Test Button

This Button is used to the insulation resistance measurements.

- Data Hold Switch

This switch is used to the switch of data hold

3 SPECIFICATIONS

Accuracy is specified for a period of year after calibration and at 18°C to 28°C (64°F to 82°F) with relative humidity to 75%.

3.1 GENERAL SPECIFICATIONS

3.1.1 Max. Voltage Between Terminals And Earth Ground: 1000V DC or AC

3.1.2 Measuring method: Dual-slope integration A/D converter

3.1.3 Sampling Time: approx. 0.4 second

3.1.4 Display: 22mm LCD

3.1.5 Max. Show Value: 1999 (3 1/2)

3.1.6 Polarity Indication: ‘-’ indicates negative polarity.

3.1.7 Overrange Indication: Display ‘1’ or ‘-1’

3.1.8 Unit showing: showing of function and electrical capacity.

3.1.9 Power Supply: 1.5V × 6 (size AA) batter (recommended to use the alkaline or heavy duty battery.)

3.1.10 Power Consumption:

Approx. 5mA (DC1000V、 AC750V、 200Ω、 1000V)

Approx. 30mA (200MΩ/250V)

Approx. 50mA (200MΩ/500V)

Approx. 100mA (2000MΩ/1000V)

3.1.11 Low Battery Indication: 'BAT' displayed**3.1.12 Operating Temperature: 0°C to 40°C (32°F to 104°F)****3.1.13 Operating Humidity: ≤ 85%RH****3.1.14 Storage Temperature: -10°C to 50°C (10°F to 122°F)****3.1.15 Dimension: 192 × 122 × 55 mm****3.1.16 Weight: Approx. 545g (including battery)****3.2 ELECTRICAL SPECIFICATIONS**

Circumstance Temperature: 23±5°C

Relative Humidity: < 75%

3.2.1 Insulation Resistance

Range	200M Ω /250V	200M Ω /500V	2000M Ω /1000V	
Test Voltage	DC 250V \pm 10%	DC 500V \pm 10%	DC 1000V \pm 10%	
Measuring Ranges	0 ~ 200M Ω	0 ~ 200M Ω	0 ~ 2000M Ω	
			0 ~ 1000M Ω	1000 M Ω ~ 2000M Ω
Accuracy	\pm 3.0% rdg \pm 5 digits			\pm 5.0% rdg \pm 5 digits

Range	200M Ω /250V	200M Ω /500V	2000M Ω /1000V
Output Voltage on Open Circuit	250V \pm 10%	500V \pm 10%	1000V \pm 10%
Minimum Output Voltage	225V at 0.25M Ω	450V at 0.5M Ω	900V at 1M Ω
Test Current (approx.)	1mA at 0.25M Ω	1mA at 0.5M Ω	1mA at 1M Ω
Output Short Circuit Current	\leq 2.5mA		

3.2.2 AC Voltage

Range	Resolution	Accuracy
700V	1V	$\pm (1.2\% \text{ of rdg} + 5 \text{ digits})$

- Input Impedance: $10M\Omega$
- Maximum Input Voltage: 700V rms AC or 1000V DC
- Frequency Range: 40 to 400Hz
- Response: Average, calibrated in rms of sine wave

3.2.3 DC Voltage

Range	Resolution	Accuracy
1000V	1V	$\pm (0.8\% \text{ of rdg} + 3 \text{ digits})$

- Input Impedance: $10M\Omega$
- Max. Input Voltage: 1000V DC or 700V rms AC

3.2.4 Resistance

Range	Resolution	Accuracy
200 Ω	0.1 Ω	\pm (1.0% of rdg + 3 digits)

- Open circuit voltage approximate 2.5V
- Overload Protection: 250V DC or rms AC

3.2.5 Continuity

Range	Function
•)	Built-in buzzer will sound, if resistance is lower than 50 Ω .

- Open circuit voltage approximate 2.5V
- Overload Protection: 250V DC or rms AC

4. OPERATING INSTRUCTION**4.1 SWITCH DISLOCATION ALARM**

When using for measuring AC voltage, DC voltage, resistance and continuity test, you must rotate the function switch to “200Ω•||), 1000V ≡ , 700V~” , rotate the range switch to “ 200Ω•||)、700V~、1000V ≡ ” ; measuring insulation resistance, you must rotate the function switch to “MAUN.、 LOCK 1min.、 LOCK 2min. 、 LOCK 4min” . Otherwise, the inside alarm system will give out a humming sound per two seconds. The indicator shows random reading.

4.2 SOUND AND FLASH ALARM

In insulation range, the test button is pressed, the inside alarming system will send out a humming sound per two seconds, also the right red high voltage output indicator of the LCD flashes.



4.3 READ HOLD

If you need data hold when measuring, you can put on “HOLD”, it will hold the reading and the showing of the LCD will be locked. If you put the switch again, data hold is not continuing.

4.4 HAND OPERATING AND TIME MEASURING

In insulation range, the function switch is rotated to “MAUN.”, the meter will be operated by hand. Once press the test button, the measurement begins; If there is a long-time measurement, you can press the test button and rotate it counter clockwise to lock position. The function switch is rotated to “LOCK 1min., LOCK 2min., LOCK 4min.”, then press the green test button, which will measure timely for one minute, two minutes and four minutes. In this course, if you want to stop measurement, you can rotate the function switch to “MAUN.” again.

4.5 PREPARATION FOR MEASUREMENT

- 4.5.1 The “” besides the input jack shows that the input voltage should be less than specification on the sticker of the meter to protect the inner circuit from damaging.
- 4.5.2 If the battery voltage is less than 7V, display will show “”, the battery should be changed at this time.

4.6 MEASURING INSULATION RESISTANCE

(See Fig 4, Fig 5, Fig 6)

Warning

Insulation tests should be conducted on circuits that are de-energized. Ensure circuits are not live before commencing testing.

Using test clips connect the meter and the tested circuit, then press test button for testing.

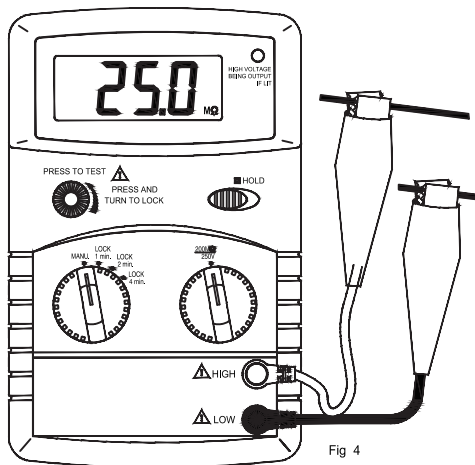
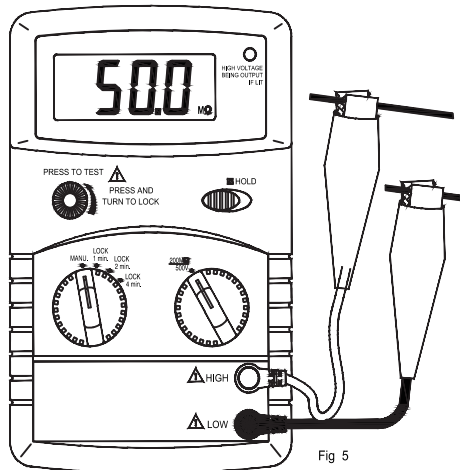

Fig 4

- 4.6.1 Select the required test mode (MANU., LOCK 1min., LOCK 2min., LOCK 4min.) by rotating the function switch.
- 4.6.2 Select the required range (200M Ω /250V, 200M Ω /500V, 2000M Ω /1000V) by rotating the range selector.
- 4.6.3 Connect the black test clip to the LOW jack and the red test clip to the HIGHjack.
- 4.6.4 Attach the test clips to the circuit to be tested.



4.6.5 Press the test button. In hand mode, you can repress the test button and then counter clockwise rotate it to the lock position.

4.6.6 You can get reading from LCD.

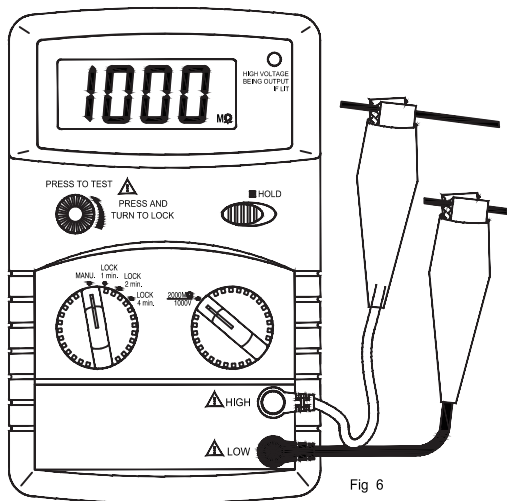

Fig 6

⚠ Warning

Never touch the circuit under test during insulation measuring.

Never rotate the range switch while the test button is pressed. This may damage the meter.

When measuring is complete ensure that the test button is released before the test clips are disconnected. This is because the system may be charged up and it must be allowed to discharge through the tester's internal discharge resistor.

4.7 MEASURING AC VOLTAGE (See Fig 7)

4.7.1 Connect the black test lead to the LOW jack and the red test lead to the HIGH jack.

4.7.2 Put the function switch on the “ $200\Omega \cdot \text{H}$ ”, $1000\text{V} \text{---}$, $700\text{V}\sim$ ” position.

4.7.3 Put the range switch on the 700V~ range position.

4.7.4 Connect test leads across the source or load under measurement.

4.7.5 You can get reading from LCD.

NOTE:

- “⚠” means you can't input the voltage which more than 700V rms AC or 1000V DC, it's possible to show higher voltage, but it's may destroy

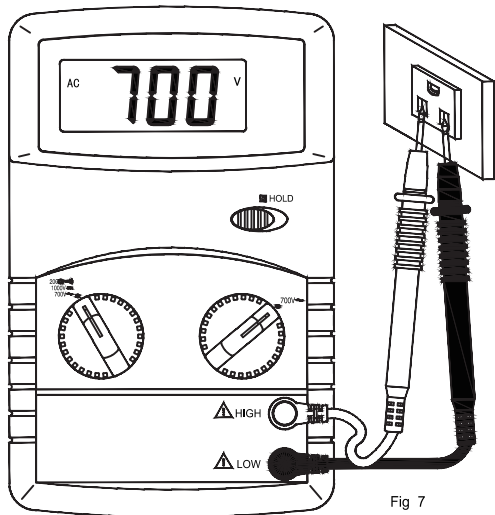

Fig 7

the inner circuit.

- Pay attention not to get an electric shock when measuring.

4.8 MEASURING DC VOLTAGE

(See Fig 8)

- 4.8.1 Connect the black test lead to the LOW jack and the red test lead to the HIGH jack.
- 4.8.2 Put the function switch on the “200Ω •||)”, 1000V \equiv , 700V~” position.
- 4.8.3 Put the range switch on the 1000V \equiv range position.

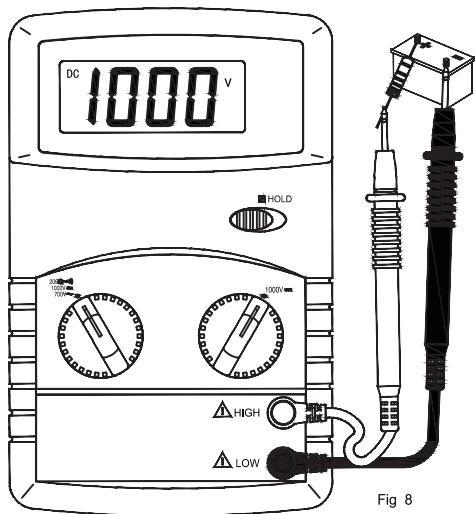

Fig 8

4.8.4 Connect test leads across the source or load under measurement.

4.8.5 You can get reading from LCD. The polarity of the red lead connection will be indicated along with the voltage value.

NOTE:

- “ \triangle ” means you can't input the voltage which more than 1000V DC or 700V rms AC, it's possible to show higher voltage, but it's may destroy the inner circuit.
- Pay attention not to get an electric shock when measuring.

4.9 MEASURING RESISTANCE (See Fig 9)

⚠ Warning

When checking in-circuit resistance, be sure the circuit under test has all power removed and that all capacitors have been discharged fully.

- 4.9.1 Connect the black test lead to the LOW jack and the red test lead to the HIGH jack.
- 4.9.2 Set the function switch on the “ $200\Omega \cdot \mu$), 1000V \equiv , 700V~ “ position.
- 4.9.3 Set the range switch on the 200Ω range position.
- 4.9.4 Connect test leads across the resistance under measurement.
- 4.9.5 You can get reading from LCD.

NOTE:

- When only the figure '1' is displayed, it indicates overrange situation.
- When the input is not connected, i.e. at open circuit, the figure '1' will be displayed for the overrange condition.

4.10 CONTINUITY TEST

(see Fig 9)

- 4.10.1 Connect the black test lead to the LOW jack and the red test lead to the HIGH jack.

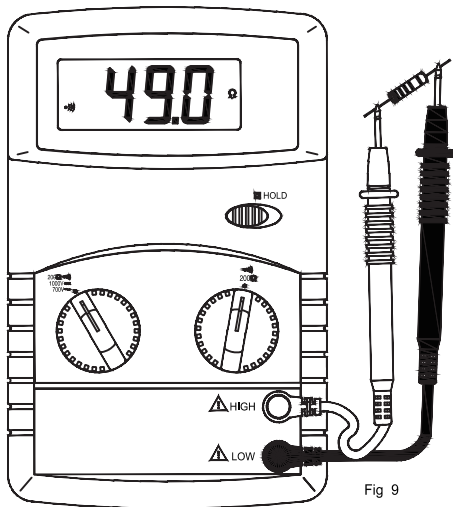

Fig 9

4.10.2 Set the function switch on

the “ $200\Omega \cdot \text{M}$ ”, $1000V \text{ } \equiv$, $700V \sim$ “ position.

4.10.3 Set the range switch on the “ M ” range position.

4.10.4 Connect test leads across two points of the circuit under testing.

4.10.5 If continuity exists (i.e., resistance less than 50Ω) , built-in buzzer will sound continuously.

NOTE:

- If the input open circuit, the figure ‘1’ will be displayed.

5. MAINTENANCE

5.1 BATTERY REPLACEMENT

(See Fig 10)

⚠ WARNING

Before attempting to remove the battery cover, be sure that test leads or test clips have been disconnected from measurement circuit to avoid electric shock hazard.

5.1.1 If the sign ‘’ appears on the LCD display, it indicates that the battery should be replaced.

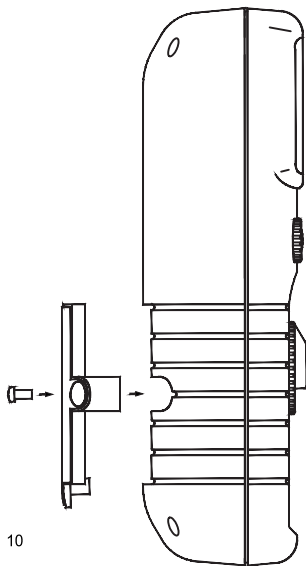

Fig 10

5.1.2 Loosen the screw fixing the battery cover and remove it.

5.1.3 Replace the exhausted battery with a new one.

5.1.4 Put the battery cover as its origin.

5.2 TEST LEADS AND TEST CLIPS REPLACEMENT

⚠ WARNING

Full in compliance with safety standards can be guaranteed only if used with test leads or test clips supplied. If necessary, they must be replaced with the same model or same electric ratings. Electric ratings of the test leads or test clips: 1000V 5A

You must replace the test leads or test clips if the lead is exposed.

6. ACCESSORIES

①	Test Leads	Electric Ratings 1000V 5A	one piece
②	Test Clips	Electric Ratings 1000V 5A	one piece
③	Battery	1.5V SIZE "AA"	six pieces
④	Operator's Manual		one piece
⑤	Screwdriver		one piece
⑥	Soft Case		one piece
⑦	Carrying Case		one piece
⑧	Packing Box		one piece



00-05-0919