

4-20HR-MaxSonar[®]-WR/WRC[™] Series

High Resolution, Precision, IP67 Weather Resistant, Ultrasonic Range Finders

MB7460, MB7469, MB7480, MB7489⁵

The 4-20HR-MaxSonar-WR sensor line is a high performance ultrasonic precision rangefinder that provides high accuracy, high resolution ultrasonic range detection in air. The 4-20HR-MaxSonar-WR sensor line is a cost-effective solution for automation/process control applications where precision range-finding, low-voltage operation, space saving, low cost and IP67 weather resistance is needed. This sensor component allows users of other more costly precision rangefinders to lower the cost of their systems without sacrificing performance. The sensor output works with existing PLC equipment and is also suitable for applications with long cable runs. The 4-20HR-MaxSonar-WR/WRC sensor line features 1.6-mm resolution, superior rejection of outside noise sources, internal speed-of-sound temperature compensation and optional external speed-of-sound temperature compensation. The sensors are factory calibrated to provide stable and reliable range readings. With a maximum range of 5 meters, these ultrasonic sensors detect objects from 5-mm and ranges to objects from 50-cm to maximum range. Objects closer than 50-cm are typically reported as 50-cm (See Close Range Operation).



Precision Ultrasonic Range Sensing

- A fraction of the cost of other precision rangefinders
- Factory-matched accuracy provides a typical accuracy of 1% or better of distance to target¹
- Reading-to-reading stability of 1.6-mm at 1-meter is typical¹
- Compensation for target size variation and operating voltage range
- Temperature compensation is standard
- Additional chemical resistance available²

Low Power Requirements

- Average power draw of 20-40mA
- Other interfaces (non4-20mA) available with lower current draw
- Flexible, low supply voltage requirements simplifies battery powered designs
- Low current draw reduces current drain for battery operation

Easy to Use Component

- Robust and easy to use interface
- Excellent noise rejection
- Small and easy to mount
- Stable, reliable range readings
- Target size compensation provides greater consistency and accuracy
- Auto handles acoustic noise^{1,3}
- Calibrated sensor eliminates most sensor-to-sensor variations
- Handles multiple sensor environments

General Characteristics

- **4-20mA with ~1.6mm resolution**
- Refresh rate of ~8Hz
- Determines range to largest object (MB7469, MB7489)
- Determines range to first detectable object (MB7460, MB7467, MB7480, MB7487)
- Excellent clutter rejection
- Low-cost ultrasonic rangefinder
- Resolution of ~1.6-mm
- Distance from 50-cm to 5-meters
- Excellent MTBF of > 200,000 hrs.
- Superior noise rejection⁴

- Operating temperature range from -40°C to +65°C
- Operating voltage from 10V to 32V
- IP67 rated

Applications & Uses

- Automated process control systems
- Tank level measurement
- Weather station monitoring
- Bin level measurement
- Corn level measurement¹
- Proximity zone detection
- People detection
- Robot ranging
- Long range object detection
- Environments with acoustic and electric noise
- Height monitors
- Auto sizing
- Box dimensions

Notes

¹ Users to evaluate the sensor performance

² F-Option provides added protection from hazardous chemical environments

³ By design

⁴ Part-specific timing information — see page 3

⁵ Please reference page 12 for part number key

Close Range Operation

Applications requiring 100% reading-to-reading reliability should not use MaxSonar sensors at a distance closer than 50cm. Although most users find MaxSonar sensors to work reliably from 0 to 50cm for detecting objects in many applications, MaxBotix Inc. does not guarantee operational reliability for objects closer than the minimum reported distance. Because of ultrasonic physics, these sensors are unable to achieve 100% reliability at close distances.

Warning: Personal Safety Applications

We do not recommend or endorse this product be used as a component in any personal safety applications. This product is not designed, intended or authorized for such use. These sensors and controls do not include the self-checking redundant circuitry needed for such use. Such unauthorized use may create a failure of the MaxBotix Inc. product which may result in personal injury or death. MaxBotix Inc. will not be held liable for unauthorized use of this component.

General Operation

The 4-20HR-MaxSonar-WR ultrasonic sensors are in-air, non-contact, object detection and ranging sensors that detect objects within an area. These sensors are not affected by the color or other visual characteristics of the detected object. Ultrasonic sensors use high frequency sound to detect and localize objects in a variety of environments. Ultrasonic sensors measure the time of flight for sound that has been transmitted to and reflected back from nearby objects. Based on the time of flight, the sensor outputs a distance value.

4-20 Sensor Connection Pin Out

Pin 6 — Ground return for the DC power supply.

The black wire will be for the cable attach.

Pin 5 — 4-20mA signal output, the analog current output has a resolution of ~1.6mm.

The brown wire will be for the cable attach.

Pin 4 — Vcc input. This sensor has an operational input voltage of 10V to 32V DC. This sensor has a nominal current draw of less than 40mA.

The red wire will be for the cable attach.

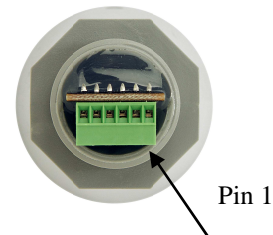

Temperature Sensor Connections

Pin 3 — Temperature sensor V+ source. This is the red connection wire on the HR-MaxTemp sensors.

Pin 2 — Temperature sensor input. This is the white connection wire on the HR-MaxTemp sensors.

Pin 1 — Temperature sensor shield.

Output Conversion Equations

Formulas to convert the sensor output are to distance provided below for convenience. Using I (mA) as the output current and d (mm) as the distance.

	Distance	Current
MB746X	$d = ((I - 4) * 4500) / 16 + 500$	$I = (((d - 500) * 16) / 4500) + 4$
MB748X	$d = 5000 - ((I - 4) * 4500) / 16$	$I = (((5000 - d) * 16) / 4500) + 4$

Scaling the 4-20mA to a 5V or 10V Analog Voltage

The 4-20HR-MaxSonar-WR sensor output can be easily scaled at the user end to match the voltage range of an existing PLC or microcontroller system equipped with an analog to digital converter by using the schematic shown to the right.

For 5V data use a resistor value of 250 ohms 0.1% — when using this resistor value the sensor **requires a minimum of 15VDC** for proper operation and runs with a voltage range of 1V to 5V.

For 10V data use a resistor value of 500 ohms 0.1% — when using this resistor value the sensor **requires a minimum of 19VDC** for proper operation and runs with a voltage range of 2V to 10V.

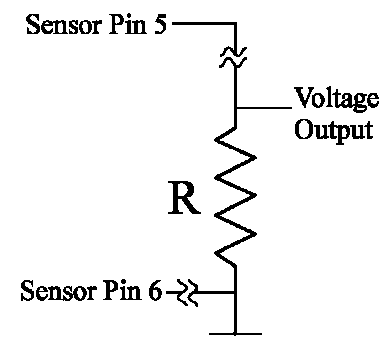

Custom products with analog voltage outputs are also available from MaxBotix Inc.

Formulas to convert the sensor output to distance are provided below for convenience. Using V (volts) as the output voltage and d (mm) as the distance.

		Distance	Voltage
5V	MB746X	$d = ((V - 1) * 4500) / 4 + 500$	$V = (((d - 500) * 4) / 4500) + 1$
5V	MB748X	$d = 5000 - ((V - 1) * 4500) / 4$	$V = (((5000 - d) * 4) / 4500) + 1$
10V	MB746X	$d = ((V - 2) * 4500) / 8 + 500$	$V = (((d - 500) * 8) / 4500) + 2$
10V	MB748X	$d = 5000 - ((V - 2) * 4500) / 8$	$V = (((5000 - d) * 8) / 4500) + 2$

4-20HR-MaxSonar-WR (MB7460 and MB7480)

The MB7460 and MB7480 are the base models of the 4-20-MaxSonar-WR sensor line. These general purpose sensors are recommended unless specific requirements indicate other sensors may be a better fit for the application. All other sensors in this series are based off of this sensor model. The additional features are mentioned in their respective sections below.

4-20HR-MaxSonar-WRM (MB7469 and MB7489)

The 4-20HR-MaxSonar-WRM sensors come with the most-likely filter features. The MB7469 output matches the output of the MB7460. The MB7489 output matches the output of the MB7480.

In general, the 4-20HR-MaxSonar-WRM sensors will select the largest target from its field of view and report its range. Even so, objects up close may provide significantly greater returns over distant objects. Users are encouraged to test the sensor in their application to verify usability.

About Package Types

The 4-20HR-MaxSonar-WR sensors are available in a variety of packages for applications with specific mounting requirements. The full horn package provides peak accuracy and sensitivity in this sensor line. It is recommended that testing is completed to ensure that the selected sensor will operate as desired in your application.

Performance Changes when Selecting a Non-Full Horn Package

Package Types Currently Available
Full Horn – 3/4" NPT straight; back mounted thread (best performance)
Compact – 3/4" NPT straight; back mounted thread
1"NPS – External thread over full sensor body (1"NPS)
1"BSPP – External thread over full sensor body (1"BSPP)
30mm1.5 – External thread over full sensor body (30mm1.5)
All package types have exposed PCB on user end for easy connection. Users desiring a fully enclosed assembly may purchase the "Shielded Cable Option" along with their sensor.



When selecting a 4-20HR-MaxSonar-WR sensor without the full horn the sensor will experience the following performance changes:

- The sensor will have a wider beam shape for the first meter.
- The sensor may be less accurate by an additional +/- 0.5%.
- The sensor may have a dead zone from 0mm–500mm.
- The sensor may have worse performance to small or soft targets.
- The sensor may experience decreased noise immunity when ranging to small, soft, angled, or distant targets.

About Ultrasonic Sensors

The HRXL-MaxSonar-WR ultrasonic sensors are in-air, non-contact object detection and ranging sensors that detect objects within an area. These sensors are not affected by the color or other visual characteristics of the detected object. Ultrasonic sensors use high frequency sound to detect and localize objects in a variety of environments. Ultrasonic sensors measure the time of flight for sound that has been transmitted to and reflected back from nearby objects. Based upon the time of flight, the sensor outputs a range reading.

Mechanical Dimensions

3/4" National Pipe Thread Straight Full Horn

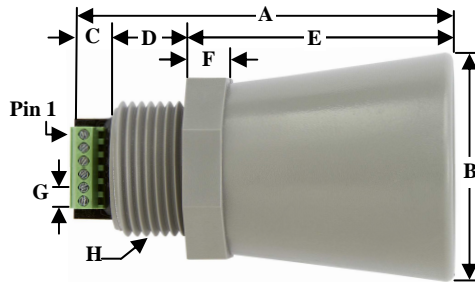

A	2.87"	72.9 mm
B	1.72" dia.	43.8 mm dia.
C	0.31"	7.9 mm
D	0.58"	14.4 mm
E	2.00"	50.7 mm
F	0.31"	7.9 mm
G	0.10"	2.54 mm
H	3/4" NPS	
I	1.37" dia.	34.8 mm dia.
J	1.03" dia.	26.2 mm dia.
K	0.41"	10.3 mm
L	0.78"	19.81 mm dia.
M	0.62"	15.76 mm
weight, 1.89 oz., 53.5 grams		

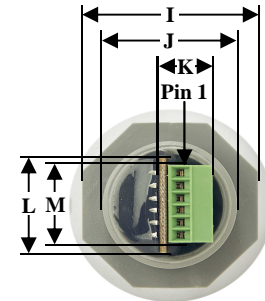

values are nominal

1" National Pipe Thread Straight

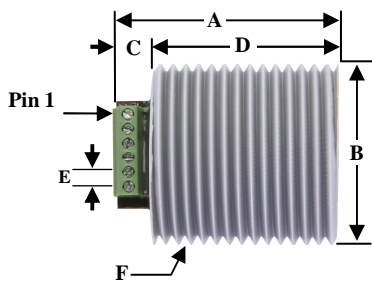

A	1.58"	40.2 mm
B	1.29" dia.	33.0 mm dia.
C	0.27"	7.0 mm
D	1.30"	33.1 mm
E	0.10"	2.54 mm
F	1" NPS	
G	0.40"	10.3 mm
H	0.78"	19.81 mm
I	0.62"	15.76 mm
weight, 1.28 oz., 36.3 grams		

values are nominal

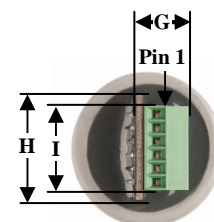

1" BSPP Pipe Thread

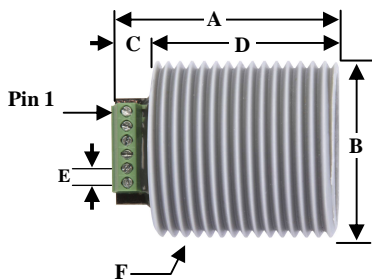

A	1.58"	40.2 mm
B	1.29" dia.	33.0 mm dia.
C	0.27"	7.0 mm
D	1.30"	33.1 mm
E	0.10"	2.54 mm
F	1" BSPP	
G	0.40"	10.3 mm
H	0.78"	19.81 mm
I	0.62"	15.76 mm
weight, 1.26 oz., 35.6 grams		

values are nominal

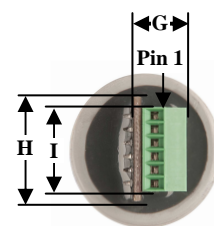

30mm 1.5 Pipe Thread

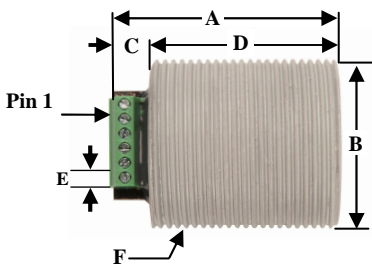

A	1.58"	40.2 mm
B	1.17" dia.	29.7 mm dia.
C	0.27"	7.0 mm
D	1.24"	31.5 mm
E	0.10"	2.54 mm
F	30mm 1.5	
G	0.40"	10.3 mm
H	0.78"	19.81 mm
I	0.62"	15.76 mm
weight, 1.14 oz., 32.4 grams		

values are nominal

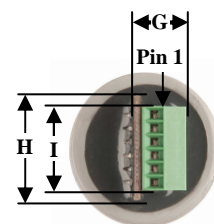

Auto Calibration

The 4-20HR-MaxSonar-WR series sensor auto calibrates each time it takes a range reading. The sensor then uses this data to range objects. If the temperature, humidity or applied voltage changes during sensor operation the sensor will continue to function normally over the rated temperature range while applying compensation for changes caused by temperature and voltage.

Sensors Minimum Distance

The MB7460 and MB7480 are the base models of the 4-20HR-MaxSonar-WR sensor line. Sensors based on the MB7460 have a relative zero set at 4mA (4mA = 500 mm; 20mA = 5000 mm) and the sensors based on the MB7480 have a relative zero of 20mA (20mA = 500 mm; 4mA = 5000 mm).

Range Zero Location

In general, the 4-20HR-MaxSonar-WR sensors report the range to the leading edge of the closest detectable object. Target detection is characterized in the sensor beam patterns.

The 4-20HR-MaxSonar-WR reports the range to distant targets from where the threading and nut meet on the sensor housing as shown in the diagrams below.

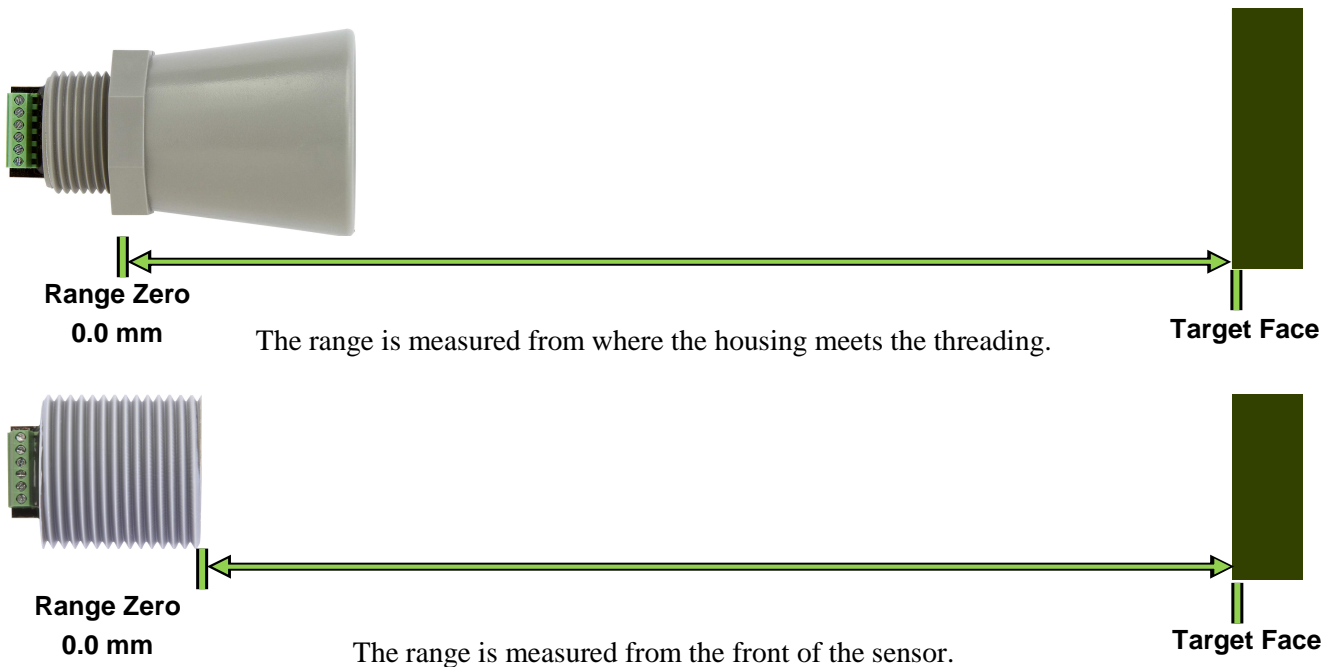

Temperature Compensation

The speed of sound in air increases by approximately 0.6 meters per second, per degree centigrade. An external temperature sensor (supplied Dongle or optional HR-MaxTemp) allows for immediate and accurate temperature compensation. Optionally, the 4-20HR-MaxSonar-WR has a built in temperature sensor.

Using the Attached Temperature Sensor Dongle

The 4-20HR-MaxSonar-WR includes an attached temperature sensor dongle. This dongle allows immediate and accurate temperature sensing of the air temperature at the sensor. This provides a typical accuracy of 1.5%, (excluding major temperature changes along the measurement path).

Using the External HR-MaxTemp — External Temperature Sensor

The temperature measured at the sensor itself may not match the air temperature of the full path between the sensor and the target. For example, sensors can be mounted in vertical applications or applications where the environment temperature gradient is severe. Users may experience a temperature measurement error which will affect the sensor accuracy. For example, buildings with a height of 3-meters can have floor-to-ceiling temperature variations of 5°C or more. Because of these temperature effects, users desiring the highest accuracy output are encouraged to use an external temperature mounted midway between the target and the sensor.

For best results in these applications, users are encouraged to remove the dongle and connect the HR-MaxTemp sensor midway between the HRXL-MaxSonar-WR and the expected target. (Remove the dongle and attach the HR-MaxTemp. This provides a typical distance accuracy of 1% or better.

Using the Optional Internal Temperature Sensor

The temperature dongle can be removed and the sensor repowered to enable the internal temperature sensor. This internal temperature sensor does not track the temperature changes as well as the external temperature sensors. Even so, if there are significant changes in temperature from the air around the back of the sensor (where the dongle is located) to the air in front of the sensor (where the transducer is located) and an external HR-MaxTemp is not practical for your application, using the internal temperature sensor is the best option. After a power up, the typical distance accuracy will be 3%.

Self-Heating

The operational characteristics of the sensor cause a natural self-heating effect. Because of the variability in the self-heating effect caused by changes in current output, the accuracy of the internal temperature sensor is limited. While the sensor will compensate for most of the self-heating effects, the surrounding environment and mounting can affect the amount of self heating.

Power cycling the sensor may cause self-heating effects that cannot be predicted by the sensor's data algorithms. It is recommended to run the sensor continuously. This steady-state operation helps to minimize reading-to-reading variability by increasing the stability of the internal temperature of the sensor.

Sensors with different output choices that are not subject to this self-heating effect are also available from MaxBotix.

Target Size Compensation

Most low-cost ultrasonic rangefinders report the range to smaller size targets as farther than the actual distance. They may also report the range to larger size targets as closer than the actual distance.

The 4-20HR-MaxSonar-WR sensor line compensates for target size differences. This means that, provided an object is large enough to be detected, the sensor will report the same distance regardless of target size. Smaller targets can have additional detection noise that may limit this feature. In addition, targets with small or rounded surfaces may have an apparent distance that is slightly farther, where the distance reported may be a composite of the sensed object(s).

Supply Voltage Compensation

During power-up the 4-20HR-MaxSonar-WR sensor line auto calibrates for changes in supply voltage. The sensor also compensates if the supplied voltage gradually changes.

The sensor requires noise free power for best operation. If the sensor is used with noise on the supplied power or ground, the readings may be affected. In general, the 4-20HR-MaxSonar-WR will not be affected by supply voltage changes provided the voltage applied remains above 10V.

Sensor Timing / Power-Up Timing

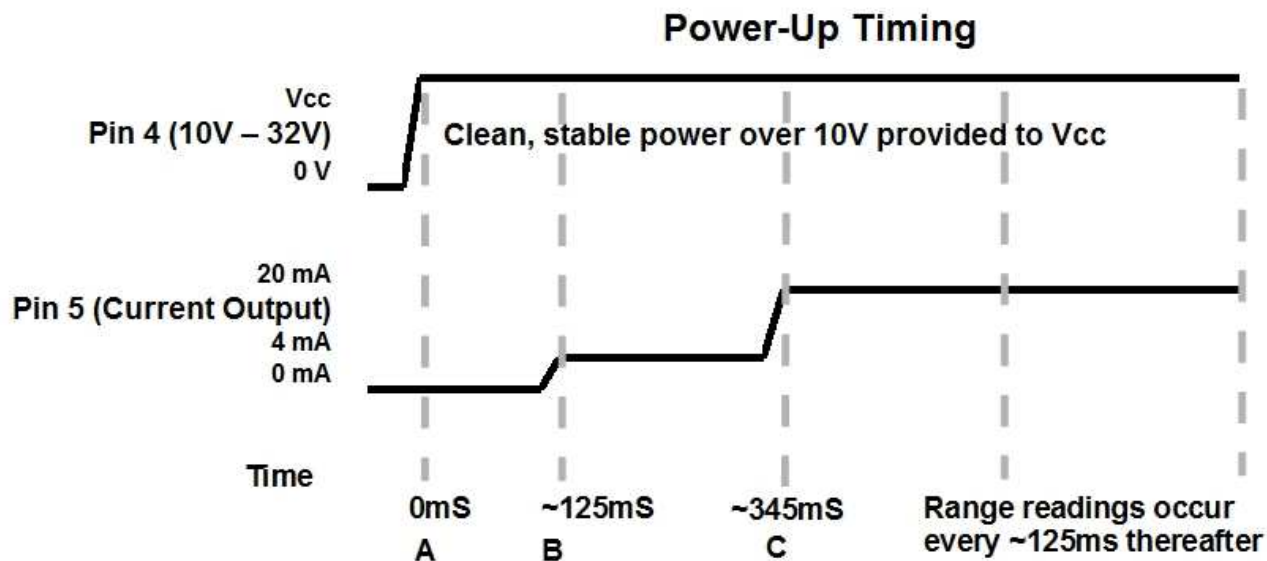

- A.** Power-Up timing begins when a voltage above 10V is maintained for the sensor.
- B.** After a ~125mS delay the sensor will idle at a low current state (4mA).
- C.** The 4-20HR-MaxSonar-WR is has data available for the user ~345mS after power-up.
- D.** Range data is sent every ~125mS thereafter, meaning that after the initial power-up, the sensor refresh rate is ~8Hz.

The 4-20HR-MaxSonar-WR series sensors use an internal filter to process range data. This filter improves the sensor's performance for accuracy, noise rejection and reading-to-reading stability. This filter responds to rapid large changes in target position at a rate of 1.1Hz. This filter does not affect the speed at which data is made available to the user, but allows for more consistent range information.

Custom Solutions

We have the ultrasonic sensor for you! If you don't find the product for your specific application, contact us and our engineers will work with you for your custom solution. Our in-house engineering department can design and manufacture custom solutions which are subject to a small NRE fee. Some of these custom solutions may later be incorporated into our standard products.

Sensor Operation

The 4-20HR-MaxSonar-WR sensors are designed to be used in a variety of outdoor industrial environments or indoor environments. Many acoustic noise sources have little to no effect on the reported range of the 4-20HR-MaxSonar-WR sensors. Most range readings are accurately reported. If the range readings are affected, it is typically less than 5-mm. This allows users to employ real-time ultrasonic distance sensing without the need for additional supporting circuitry or complex user software.

Multiple 4-20HR-MaxSonar-WR sensors can be operated in the same general locations. The internal noise filter is able to filter out the ultrasonic noise from other 4-20HR-MaxSonar-WR sensors with minimal interference. Typically, when operating with multiple sensors, the range readings will be within ± 1 cm of the actual range to the intended target.

The 4-20HR-MaxSonar-WR sensors use an internal filter to process range data. This filter improves the sensor's performance for accuracy, noise rejection and reading-to-reading stability. The filtering during operation also permits additional acoustic and electric noise tolerance. This filter is applied to all readings and updates at a rate of 1.1Hz.

Beam Patterns Background

Each 4-20HR-MaxSonar-WR sensor has a calibrated beam pattern. Each sensor is matched to provide the approximate detection pattern shown in this datasheet. This allows users to select the part number that matches their given sensing application. Each part number has a consistent field of detection so additional units of the same part number will have similar beam patterns. The beam patterns are provided to help identify an estimated detection zone for an application based on the acoustic properties of a target.

Each beam pattern is a 2D representation of the detection area of the sensor. The beam pattern is actually shaped like a 3D cone (having the same pattern both vertically and horizontally). Beam patterns for dowels are used to show the beam pattern of each sensor. Dowels are long cylindrical targets of a given diameter. The dowels provide consistent target detection characteristics for a given size target which allows easy comparison of one MaxSonar sensor to another MaxSonar sensor.

For each part number, the four patterns (A, B, C and D) represent the detection zone for a given target size. Each beam pattern shown is determined by the sensor's part number and target size.

The actual beam angle changes over the full range. Use the beam pattern for a specific target at any given distance to calculate the beam angle for that target at the specific distance. Generally, smaller targets are detected over a narrower beam angle and a shorter distance. Larger targets are detected over a wider beam angle and a longer distance.

People Sensing

For users who need to detect people, the detection area to the 1-inch diameter dowel generally represents the area that the sensor will reliably detect people.

MB7460-MB7480 4-20HR-MaxSonar-WR Beam Pattern & Uses

The 4-20HR-MaxSonar-WR product line has a narrow sensor beam that provides reliable long range detection zones.

MB7460-1XX MB7480-1XX

4-20HR-MaxSonar® -WR™ Beam Pattern

Sample results for measured beam pattern are shown on a 30-cm grid. The detection pattern is shown for dowels of varying diameters that are placed in front of the sensor

A 6.1-mm (0.25-inch) diameter dowel

B 2.54-cm (1-inch) diameter dowel

C 8.89-cm (3.5-inch) diameter dowel

D 11-inch wide board moved left to right with the board parallel to the front sensor face.

This shows the sensor's range capability.

Note: For people detection the pattern typically falls between charts A and B.

■ ■ Partial Detection

— Normal Detection **B**

A

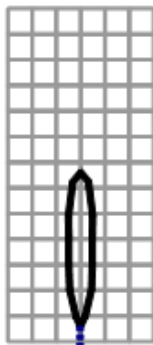

B

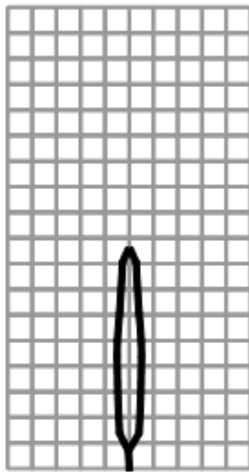

C

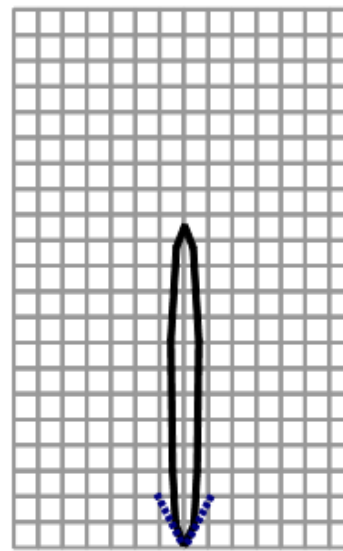

D

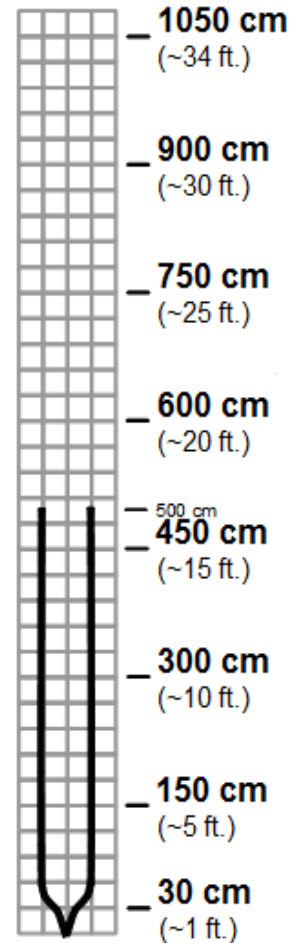

Beam Characteristics are Approximate

Beam Pattern drawn to a 1:95 scale for easy comparison to our other products.

MB7460 / MB7480 Features & Benefits

- Factory calibrated beam pattern
- Functions well in high noise environments
- Stable and highly reliable range readings
- Excellent noise and clutter rejection
- High acoustic sensitivity
- Low current draw
- High quality, low cost
- Minimal sensor-to-sensor variability

MB7460 / MB7480 Features & Benefits cont.

- Handles multiple sensor environments
- Maximum range of 5 meters
- ~1.6mm resolution
- IP67 rated
- Operating voltage from 10V to 32V
- >200,000 hrs. MTBF

MB7460 / MB7480 Applications & Uses

- Automated process control systems
- Weather station monitoring
- Bin level measurement
- Proximity zone detection
- Environments with acoustic and electric noise
- Height monitors
- Auto sizing
- Box dimensions
- People detection
- Robot ranging

MB7469-MB7489 4-20HR-MaxSonar-WRM Beam Pattern & Uses

The 4-20HR-MaxSonar-WRM product line has a narrow sensor beam that provides reliable long range detection zones. These sensors also feature the Most-Likely filter that report the range to the target with the largest acoustic reflection.

MB7469-1XX MB7489-1XX
4-20HR-MaxSonar® -WRM™ Beam Pattern

Sample results for measured beam pattern are shown on a 30-cm grid. The detection pattern is shown for dowels of varying diameters that are placed in front of the sensor
A 6.1-mm (0.25-inch) diameter dowel
B 2.54-cm (1-inch) diameter dowel
C 8.89-cm (3.5-inch) diameter dowel
D 11-inch wide board moved left to right with the board parallel to the front sensor face. This shows the sensor's range capability.

Note: For people detection the pattern typically falls between charts A and B.

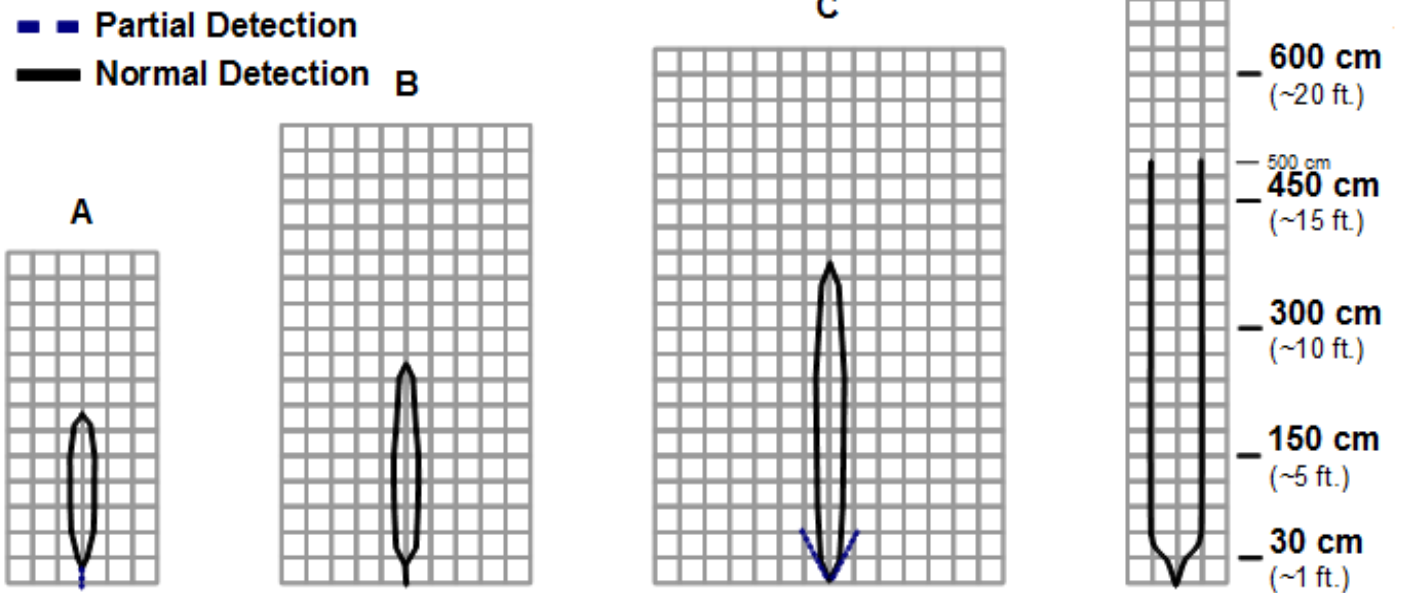

Beam Characteristics are Approximate

Beam Pattern drawn to a 1:95 scale for easy comparison to our other products.

MB7469 / MB7489 Features & Benefits

- Factory calibrated beam pattern
- Functions well in high noise environments
- Stable and highly reliable range readings
- Excellent noise and clutter rejection
- High acoustic sensitivity
- Low current draw

MB7469 / MB7489 Features & Benefits cont.

- Maximum range of 5 meters
- ~1.6mm resolution
- IP67 rated
- Operating voltage from 10V to 32V
- >200,000 hrs. MTBF
- Minimal sensor-to-sensor variability
- High quality, low cost

MB7469 / MB7489 Applications & Uses

- Automated process control systems
- Tank level measurement
- Weather station monitoring
- Bin level measurement
- Environments with acoustic and electric noise
- Height monitors
- Auto sizing
- Box dimensions

MB746X-MB748X 4-20HR-MaxSonar-WR Beam Patterns & Uses

The 4-20HR-MaxSonar-WR product line is available in alternative housings that include a compact WRC form factor, 1" NPS, 1" BSPP, and 30mm1.5 threading.

MB7460-2XX	MB7469-2XX	MB7480-2XX	MB7489-2XX
MB7460-5XX	MB7469-5XX	MB7480-5XX	MB7489-5XX
MB7460-6XX	MB7469-6XX	MB7480-6XX	MB7489-6XX
MB7460-7XX	MB7469-7XX	MB7480-7XX	MB7489-7XX

4-20HR-MaxSonar®- Beam Pattern

Sample results for measured beam pattern are shown on a 30-cm grid. The detection pattern is shown for dowels of varying diameters that are placed in front of the sensor
A 6.1-mm (0.25-inch) diameter dowel
B 2.54-cm (1-inch) diameter dowel
C 8.89-cm (3.5-inch) diameter dowel

D 11-inch wide board moved left to right with the board parallel to the front sensor face. This shows the sensor's range capability.
Note: For people detection the pattern typically falls between charts A and B.

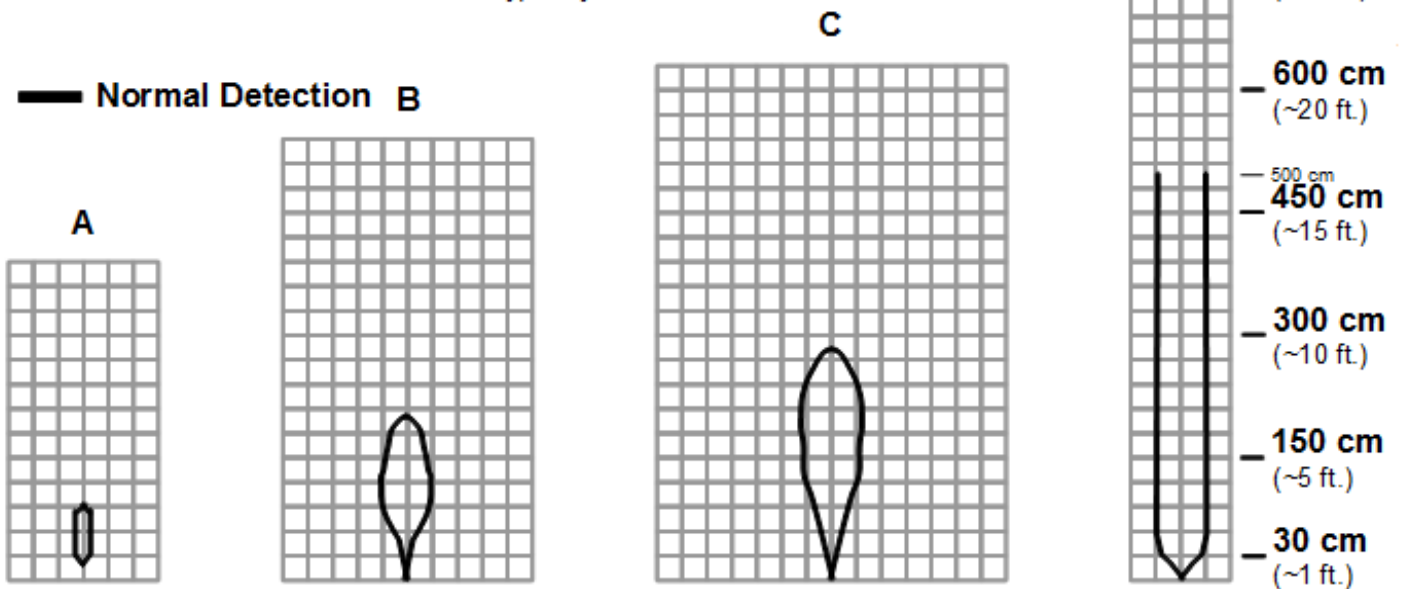

Beam Characteristics are Approximate

Beam Pattern drawn to a 1:95 scale for easy comparison to our other products.

MB746X / MB748X Features & Benefits

- Can be flush mounted in an application
- Same resolution as full horn housing
- Available in both metric and imperial housing sizes

MB746X / MB748X Applications & Uses

- Tank level measurement
- Bin level measurement
- Environments with acoustic and electrical noise
- Auto sizing

Part Numbers

All part numbers are a combination of a six-character base followed by a dash and a three-digit product code. Please review the following table for more information on the three-digit product code.

Note: Active part numbers listed on pages 13 and 14.

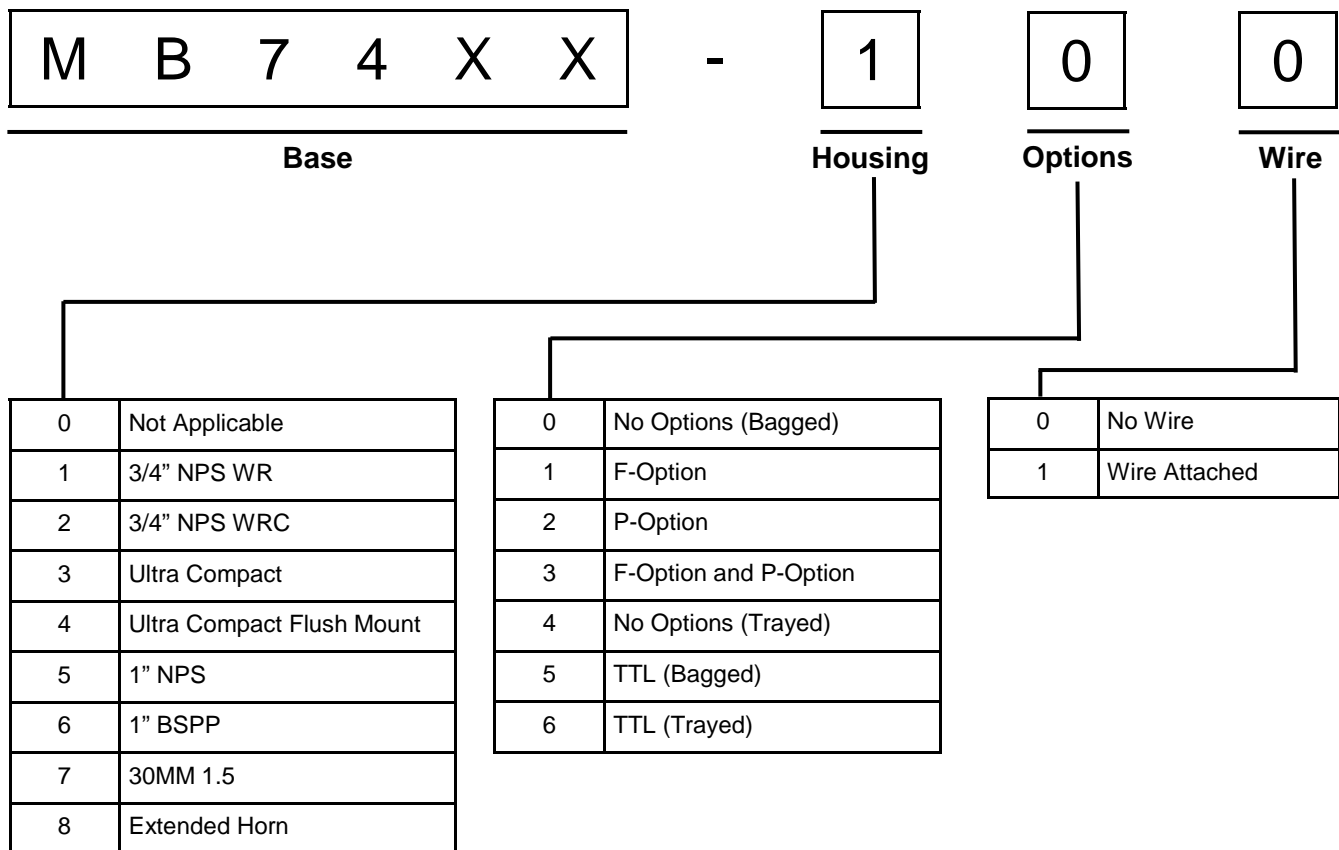

The following tables display all of the active and valid part numbers for these products.

Active Part Numbers for MB7460

MB7460-100	MB7460-101	MB7460-110	MB7460-111	MB7460-120	MB7460-121	MB7460-130	MB74760-131
MB7460-200	MB7460-201	MB7460-210	MB7460-211	MB7460-220	MB7460-221	MB7460-230	MB7460-231
MB7460-500	MB7460-501	MB7460-510	MB7460-511	MB7460-520	MB7460-521	MB7460-530	MB7460-531
MB7460-600	MB7460-601	MB7460-610	MB7460-611	MB7460-620	MB7460-621	MB7460-630	MB7460-631
MB7460-700	MB7460-701	MB7460-710	MB7460-711	MB7460-720	MB7460-721	MB7460-730	MB7460-731

Active Part Numbers for MB7469

MB7469-100	MB7469-101	MB7469-110	MB7469-111	MB7469-120	MB7469-121	MB7469-130	MB7469-131
MB7469-200	MB7469-201	MB7469-210	MB7469-211	MB7469-220	MB7469-221	MB7469-230	MB7469-231
MB7469-500	MB7469-501	MB7469-510	MB7469-511	MB7469-520	MB7469-521	MB7469-530	MB7469-531
MB7469-600	MB7469-601	MB7469-610	MB7469-611	MB7469-620	MB7469-621	MB7469-630	MB7469-631
MB7469-700	MB7469-701	MB7469-710	MB7469-711	MB7469-720	MB7469-721	MB7469-730	MB7469-731

Active Part Numbers for MB7480

MB7480-100	MB7480-101	MB7480-110	MB7480-111	MB7480-120	MB7480-121	MB7480-130	MB7480-131
MB7480-200	MB7480-201	MB7480-210	MB7480-211	MB7480-220	MB7480-221	MB7480-230	MB7480-231
MB7480-500	MB7480-501	MB7480-510	MB7480-511	MB7480-520	MB7480-521	MB7480-530	MB7480-531
MB7480-600	MB7480-601	MB7480-610	MB7480-611	MB7480-620	MB7480-621	MB7480-630	MB7480-631
MB7480-700	MB7480-701	MB7480-710	MB7480-711	MB7480-720	MB7480-721	MB7480-730	MB7480-731

Active Part Numbers for MB7489

MB7489-100	MB7489-101	MB7489-110	MB7489-111	MB7489-120	MB7489-121	MB7489-130	MB7489-131
MB7489-200	MB7489-201	MB7489-210	MB7489-211	MB7489-220	MB7489-221	MB7489-230	MB7489-231
MB7489-500	MB7489-501	MB7489-510	MB7489-511	MB7489-520	MB7489-521	MB7489-530	MB7489-531
MB7489-600	MB7489-601	MB7489-610	MB7489-611	MB7489-620	MB7489-621	MB7489-630	MB7489-631
MB7489-700	MB7489-701	MB7489-710	MB7489-711	MB7489-720	MB7489-721	MB7489-730	MB7489-731

The legacy part numbers MB7467 and MB7487 are now contained within MB7460 and MB7480 which are the base for all housing options on these products. To select a product with a legacy part number, select the desired housing option on the product with the appropriate base. Please review the following table for more information.

IF YOU BOUGHT	NOW BUY	
Legacy Part Number	Base and Housing	Active Part Number
MB7467– Compact	MB7460 in 3/4" NPS WRC Housing	MB7460-2XX
MB7467– 1" NPS	MB7460 in 1" NPS Housing	MB7460-5XX
MB7467– 1" BSPP	MB7460 in 1" BSPP Housing	MB7460-6XX
MB7467– 1" 30mm1.5	MB7460 in 1" 30mm1.5 Housing	MB7460-7XX
MB7487– Compact	MB7480 in 3/4" NPS WRC Housing	MB7480-2XX
MB7487– 1" NPS	MB7480 in 1" NPS Housing	MB7480-5XX
MB7487– 1" BSPP	MB7480 in 1" BSPP Housing	MB7480-6XX
MB7487– 1" 30mm1.5	MB7480 in 1" 30mm1.5 Housing	MB7480-7XX