

MAS830 SERIES

Digital Multimeter

Instruction Manual

for

MAS830 MAS830B MAS830L

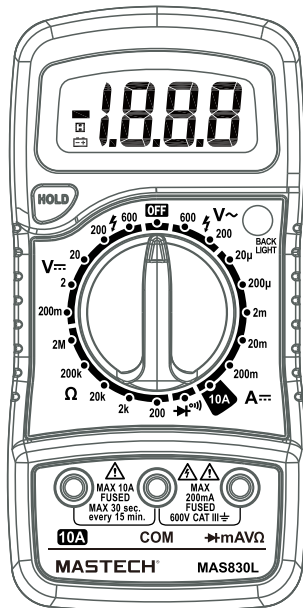

Introduction

The instrument of this series is a small hand-held 3 1/2 digital multimeter. Stable, highly reliable and anti-drop performance. It is provided with a LCD display of 15 mm height for clear reading. The circuit design takes LSI double integral A/D converter as its core under the protection of an overload protection circuit, making it a superior and handy instrument. It can be used to measure DC and AC voltage, DC current, resistance, diodes and for in-circuit continuity test.

Measurement features of the types of this series:

| Features | MAS830 | MAS830B | MAS830L |
|---------------------------------|------------------|---------|---------|
| Alternating Voltage measurement | V~ ● | ● | ● |
| Direct Voltage measurement | V ^m ● | ● | ● |
| Direct current measurement | A ^m ● | ● | ● |
| Resistance measurement | Ω ● | ● | ● |
| Diode measurement | ▶ ● | ● | ● |
| On-off measurement | o) ● | ● | ● |
| Data hold | ● | ● | ● |
| Backlight | ● | ● | ● |

FRONT PANEL

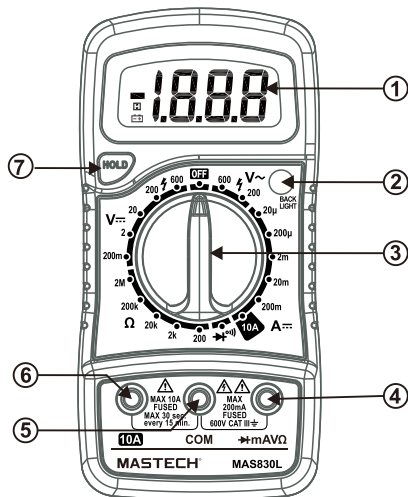

1. Display

3 1/2 digital LCD display.

2. BACKLIGHT(MAS830L)

Press the BACKLIGHT button to turn on the backlight which will last 5 seconds, to turn it on again, hit the button as needed.

3. Function and range switch

Select different functions and range.

4. VΩmA Jack

5.COM Jack

6.10A Jack

7.Data hold button

Press the HOLD button. The LCD will hold the last reading measured and display the  symbol. When the button is released, the instrument will return to normal.









Safety Information

MAS830, MAS830B, MAS830L Digital Multimeters are designed based on IEC61010, 600V CAT III and pollution degree 2.

Warning

The special attention should be paid when using the meter because the improper usage may cause electric shock and damage the meter. The safety measures in common safety regulations and operating instruction should be complied with when using. In order to make fully use of its functions and ensure safe operations please comply with the usage in this section carefully.

Safety Signs

| | |
|---|--|
|  | Important safety information. Read the manual. |
|  | High voltage with danger. |
|  | Ground. |
|  | Double Insulation (Class II safety equipment). |
|  | Fuse must be replaced as per the specification herein. |
|  | Accord with the related EU laws and regulations |
|  | AC (Alternating Current) |
|  | AC (Alternating Current) |

Notices

- The instrument can only be used in conjunction with the probe for the compliance with safety standards. If the probe needs replacing due to damage, the replacement must be of the same type or the same electrical specifications.
- Do not exceed the input limits specified for each range.

- When the instrument is measuring, do not touch the input terminal not in use.
- When a measurement range is uncertain, turn the function/range switch to the maximum range position.
- Before turning the function/range switch, make sure the probe is open with the circuit being measured.
- Before on-line resistance measurement, turn off all power and discharge all capacitors.
- Be careful when taking measurement of voltage higher than 60V DC/30V AC. Remember to keep your fingers behind the hand shield of the probe.
- When measuring a TV set or switch power supply, watch for pulse in the circuit that may damage the multimeter.
- Measure known voltage with the meter to verify that the meter is working properly. If the meter is working abnormally, stop using it immediately. A protective device may be damaged. If there is any doubt, please have the meter inspected by a qualified technician.
- Before taking the measurement of voltage with the probe, make sure there is no electronic element connected to the test socket of the transistor.

Maintenance

- Before removing the rear cover, disconnect the probe from the circuit to be measured.
- To protect the internal circuit, replace the fuse with one of the same specification:
F1:FF 250mA H 600V,10KA ; F2:FF 10A H 600V,10KA
- Don't use the instrument until the rear cover is placed back and the screws are tightened.
- Clean the housing of instrument only with a wet rag dripped with little detergent but never chemical solution.
- In case of any abnormality, stop using it and sent it for maintenance.

Accuracy Indicators

Accuracy: \pm (% of reading + digits) with one year of warranty.
Reference conditions: environmental temperature is from 18°C~28°C, relative humidity is not more than 80%.

General features:

| | |
|--------------------------|--|
| Safety Class | CAT III 600V |
| waterproof | IP20 |
| Fuse | F1:FF 250mA H 600V,10KA, F2:FF 10A H 600V,10KA |
| Power | 9V battery, NEDA 1604 or 6F22 |
| Maximum display value | 1999 |
| Over-range indication | " 1 " |
| Polarity display | " - " for negative polarity |
| Low voltage indication | "  " on the display |
| Operating temperature | 0~40°C(32~104°F) |
| Storage temperature | -10~50°C(14~122°F) |
| Relative humidity | <80% RH |
| Altitude | <2000m |
| Dimension (LxWxH) | 144X74X40mm |
| Weight(no rubber case) | about 160g |
| Weight(with rubber case) | about 250g |

Direct voltage measurement

| Range | Resolution | Accuracy |
|-------|-------------|---|
| 200mV | 100 μ V | $\pm 0.5\%$ of reading , ± 3 digits |
| 2V | 1mV | $\pm 0.5\%$ of reading , ± 3 digits |
| 20V | 10mV | $\pm 0.5\%$ of reading , ± 3 digits |
| 200V | 100mV | $\pm 0.5\%$ of reading , ± 3 digits |
| 600V | 1V | $\pm 0.8\%$ of reading , ± 5 digits |

Overload protection:

200mV range: 250V DC or RMS. AC

The rest range: 600V DC or RMS. AC

Alternating voltage measurement

| Range | Resolution | Accuracy |
|-------|------------|--|
| 200V | 100mV | $\pm 1.2\%$ of reading , ± 10 digits |
| 600V | 1V | $\pm 1.2\%$ of reading , ± 10 digits |

Overload protection: 600V DC or RMS. AC

Frequency range: 40Hz to 400Hz

Display: Average (effective value of sinusoid)

Direct current measurement

| Range | Resolution | Accuracy |
|-------------|--------------|---|
| 20 μ A | 0.01 μ A | $\pm 1\%$ of reading , ± 3 digits |
| 200 μ A | 0.1 μ A | $\pm 1\%$ of reading , ± 3 digits |
| 2mA | 1 μ A | $\pm 1\%$ of reading , ± 3 digits |
| 20mA | 10 μ A | $\pm 1\%$ of reading , ± 5 digits |
| 200mA | 100 μ A | $\pm 1.5\%$ of reading , ± 5 digits |
| 10A | 10mA | $\pm 3\%$ of reading , ± 10 digits |

Overload protection:

F1:FF 250mA H 600V, 10KA ; F2:FF 10A H 600V, 10KA

Resistor

| Range | Resolution | Accuracy |
|---------------|--------------|---|
| 200 Ω | 0.1 Ω | $\pm 0.8\%$ of reading , ± 5 digits |
| 2k Ω | 1 Ω | $\pm 0.8\%$ of reading , ± 2 digits |
| 20k Ω | 10 Ω | $\pm 0.8\%$ of reading , ± 2 digits |
| 200k Ω | 100 Ω | $\pm 0.8\%$ of reading , ± 2 digits |
| 2M Ω | 1k Ω | $\pm 1.0\%$ of reading , ± 5 digits |

Maximum open circuit voltage: 3.2V

Overload protection: 250V DC or RMS. AC



Diode and circuit on-off measurement

| Range | Description |
|-------|--|
| ◌)) | When the on-resistance is smaller than (70 \pm 30) Ω , the built-in buzzer will beep. |
| ➔ | Displays the approximate diode positive voltage. |

Overload protection: 250V DC or RMS. AC

Operating Instructions

Notices before operation:

1. Plug the instrument in, check the 9V battery, if it is low, the symbol  will display, requiring battery replacement; otherwise follow the steps below.
2. The  besides the probe jack indicates that the input voltage or current should not exceed the specified limits to protect the internal circuit.
3. Before measurement, turn the function/range switch to the desired range.

Direct voltage measurement

1. Insert the red probe into the “**VΩmA**” jack and the black one into the **COM** jack.
2. Turn the function/range switch to the range of **V \sim** and connect the probe to the power supply or load to be measured. The polarity touched by the red probe will be on the display.

Warning

1. If you do not know the measured voltage range in advance, set the function/range switch to the maximum range, and then gradually turn to smaller ranges until satisfactory resolution.
2. If the display shows “1”, this indicates an overrange measurement, and the switch should be set to a higher range.
3. Do not input a voltage of more than 600V, it is capable of indicating a higher voltage, but with the risk of damaging the inside circuit.
4. When taking the measurement of high voltage, pay special attention to avoid an electric shock.

Alternating voltage measurement

1. Place the red probe into the “**VΩmA**” jack and the black one into the **COM** jack.
2. Turn the switch to **V \sim** and connect the probe to the power supply or load to be measured.

Direct current measurement

1. Place the black probe into the COM jack. for current to be measured not exceeding 200mA, put the red one into the “**V.Ω.mA**” jack. For current to be measured between 200mA and 10A, insert the red probe into the 10A jack.
2. Set the function/range switch to the desired **A $\overline{\sim}$** range, and connect the probe in series with the load to be measured. The current value and the polarity connected to the red probe will be shown on the display.

Warning

1. If you do not know the measured current range in advance, set the function/range switch to the maximum range, and then gradually turn to smaller ranges until satisfactory resolution.
2. If the display shows “1”, this indicates an overrange measurement, and the switch should be set to a higher range.
3. The symbol  besides the probe indicates the maximum input current is 200mA or 10A, depending on the inserted jack. Overcurrent will blow the fuse.

Resistance measurement

1. Place the black probe into the COM jack and the red one into the **V/Ω/Hz** jack.
2. Turn the switch to the COM jack, and connect the probe to the resistor being measured and read the results on the display.

Warning

1. If the resistor being measured is greater than the maximum value of the selected range, the display will show “1”, requiring the selection of a higher range. It normally takes a few seconds for the reading to get stable when measuring a resistor larger than 1MΩ.
2. In default of input, for instance, open circuit, the display shows “1”.
3. When measuring an online resistor, de-energized the circuit being measured and discharge all capacitors.

Diode measurement

1. Insert the black probe into the COM socket and the red one into the **V.Ω.mA**, then the red probe will be of positive polarity.
2. Turn the switch to the **▶** range, and connect the red probe to the positive pole of the diode being measured and the black one to the negative pole, read the approximate forward voltage drop of the diode on the display.

Circuit On-Off measurement

1. Insert the black probe into the COM jack and the red one into the **V.Ω.mA** jack.
2. Turn the switch to the **⦿** position and connect the probes in parallel with two points of the circuit being measured. If the resistance between the two points is less than 100Ω, the built-in buzzer will beep to indicate the continuity between the two points.

Replacement of battery and fuse

1. Under normal conditions, it is unnecessary to replace the fuse. Don't replace it until the probes are unplugged and the power is shut down. Take out the screws of the rear cover to remove the housing.
2. The replacement of the fuse should be of the same specification:
F1:FF 250mA H 600V,10KA; F2:FF 10A H 600V,10KA.
3. The replacement of battery should be of the same specification:9V NEDA 1604 or 6F22.
4. Don't put the instrument into use until the rear cover is screwed after replacing battery or fuse.

**Warning**

To avoid electric shock, make sure the probes are disconnected from the measured circuit before removing the rear cover. Make sure the rear cover is tightly screwed before using the instrument.

Replace test leads

If insulation on leads is damaged, replace test leads.

**Warning**

Use meet EN 61010-031 standard, rated CAT III 600V, or better test leads.

Attachments

- Instruction Manual: one copy
- Probe: one pair
- Package: one piece
- 9 V battery NEDA 1604 or 6F22: one provided (in the multimeter)
- Rubber case (Optional)



00-05-3887