

AHT21B Product manuals

Temperature and Humidity sensor

- Full calibration
- Digital output, I²C interface
- Excellent long-term stability
- Quick response and strong anti-jamming capability

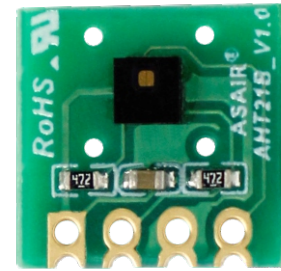

Product Overview

AHT21B is a temperature and humidity composite sensor with calibrated digital signal output. It applies special digital module acquisition technology and temperature and humidity sensor technology to ensure that the product has extremely high reliability and excellent long-term stability. The sensor outputs calibrated digital signals in standard IIC format.

AHT21B is equipped with a newly designed ASIC dedicated chip, an improved MEMS semiconductor capacitive humidity sensor element and a standard on-chip temperature sensor element. Its performance has reached the industry's advanced level. The improved new generation temperature and humidity sensor makes it The performance is more stable in harsh environments, and good accuracy is maintained in a larger

measurement range

Aosong Electronics has made improvements to the new generation of sensors with wide voltage and low power consumption, so that the terminal equipment will be energy-saving operation. Each sensor has been calibrated and tested to ensure the high quality of the products. The products can be customized according to the customer's actual application scenarios and cost considerations, starting from the details of the chip, PCB board, housing, protective cover, wire, etc., and freely combine customized products. The optional protective cover and dust cover can effectively prevent the influence of dust and water vapor on the sensor chip, and extend the use of the product use life.

Application Scope

HVAC, dehumidifier, testing and inspection equipment, consumer products, automobiles, automatic control, data loggers, weather stations, home appliances, humidity control, medical and other related temperature and humidity detection and control.

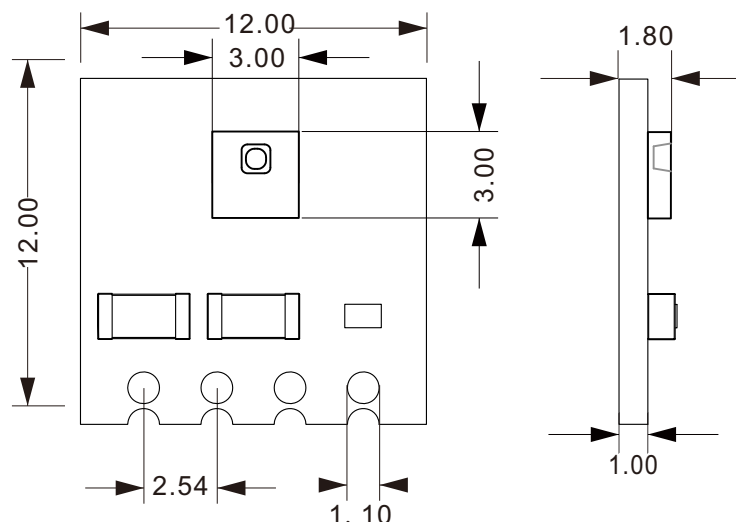

Figure1: AHT21B Sensor Package Diagrams (Unit: mm Tolerance: 0.2mm)

Sensor Performance

Relative Humidity

Parameter	condition	Min	Typical	Max	Unit
resolution	Typical		0.024		%RH
accuracy error ¹	Typical		±2		%RH
	Max	Figure 2			%RH
Repeatable			±0.1		%RH
Hysteresis			±1		%RH
Nonlinear			<0.1		%RH
Response time ²	t 63%		8		S
Scope of work	extended ³	0		100	%RH
Long time drift ⁴	Normal		<1		%RH/yr

Table 1: Humidity Characteristics

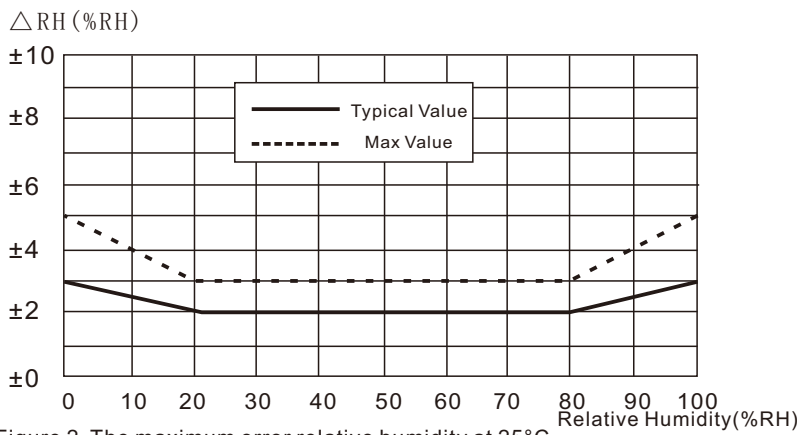

Figure 2 The maximum error relative humidity at 25°C.

Temperature

Parameter	condition	Min	Typical	max	unit
resolution ratio	Typical		0.01		°C
accuracy error ¹	Typical		±3		°C
	Max	Figure 3			°C
Repeatability			±0.1		°C
Hysteresis			±0.1		°C
Response time ⁶	t 63%	5		30	S
Scope of work	extended ³	-40		80	°C
Prolonged Drift			<0.1		°C/yr

Table 3 Temperature Characteristics

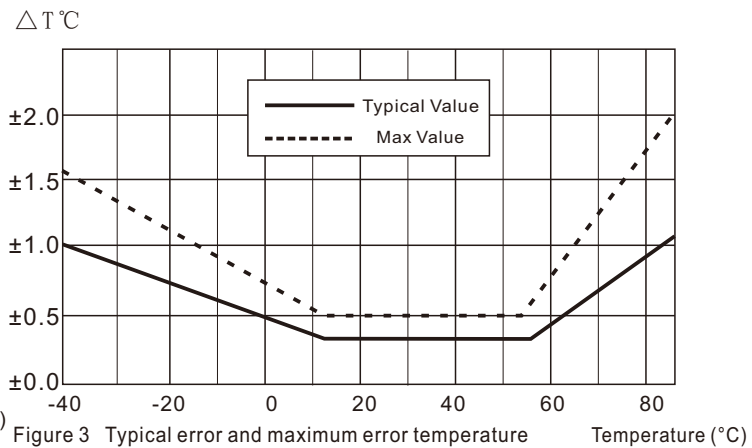

Figure 3 Typical error and maximum error temperature

Electric Specification.

Parameter	condition	Min	Typical	Max	Unit
Voltage	Typical	2.0	3.3	5.5	V
Current, ICC ⁵	Dormancy	-		250	nA
	Measure		320		μA
Power consumption ⁵	Dormancy	-		1.3	μW
	Measure		1.05		mW
	Average	-	-	-	μW
Communication	Two-line digital interface, standard I ² C protocol				

Table 2 Electric Specification.

Packaging Information

AHT21B	Tray packaging	50PCS/disk(MAX)
--------	----------------	-----------------

Table 4 Packaging Information.

1. This precision is the test accuracy of the sensor under the condition of power supply voltage of 3.3V at 25°C during delivery inspection. This value excludes hysteresis and nonlinearity and applies only to non-condensing conditions.
 2. At 25°C and 1m/s air flow, it takes 63% time to reach the first-order response.
 3. Normal operating range: 0-80%RH, beyond this range, there will be deviation in the sensor reading (after 200 hours in 90%RH humidity, drift <3%RH).

4. If the sensor is surrounded by volatile solvents, pungent tape, adhesives, and packaging materials, readings may be elevated. Please refer to the relevant documentation for details.
 5. The minimum and maximum values of supply current and power consumption are based on VCC = 3.3V and T < 60°C. The average value is the number of measurements taken every two seconds.
 6. The response time depends on the thermal conductivity of the sensor substrate.

AHT21B User Guide

1 Extended of Performance

1.1 Working Conditions

The sensor performs reliably within the recommended operating range, see Figure 4. Prolonged exposure to conditions outside the normal range, especially at humidity > 80%, may result in temporary signal drift (+3%RH after 60 hours). When normal operating conditions are restored, the sensor will slowly return to its corrected state. Refer to section 2.3 "Recovery Process" to speed up the recovery process. Prolonged use under abnormal conditions may accelerate product aging.

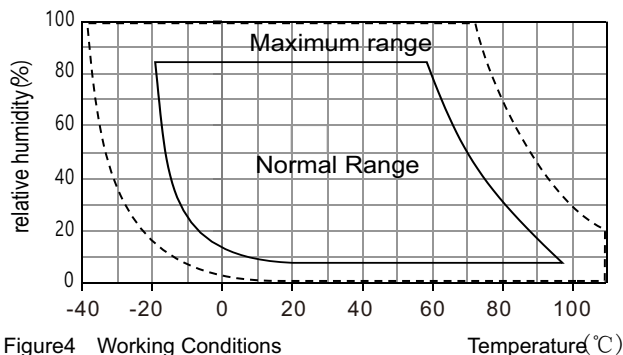

Figure4 Working Conditions

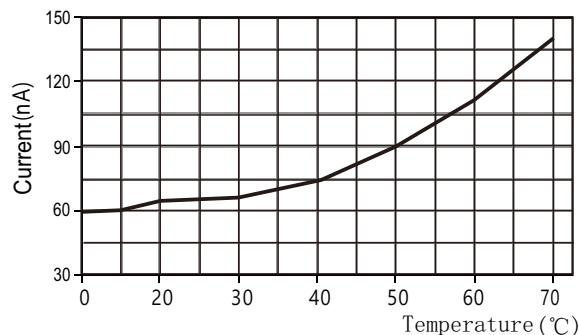

Figure 6: When VCC=3.3V, the relationship curve between typical supply current and temperature (sleep mode). Note that these data are approximately $\pm 25\%$ off the displayed values.

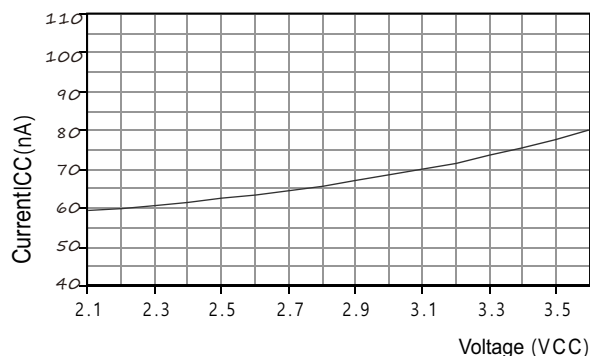

Figure 7: At a temperature of 25°C, the typical supply current is plotted against the supply voltage (sleep mode). Note that the deviation from the displayed value may be $\pm 50\%$ of the displayed value. At 60°C, the coefficient is approximately 15 (compared with Table 2)

1.2 RH accuracy at different temperatures

The RH accuracy at 25°C is defined in Figure 2, and the maximum humidity error for the other temperature bands is shown in Figure 5.

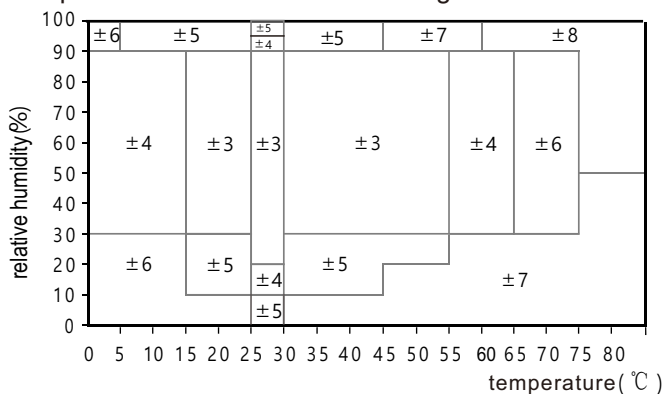

Figure 5 :The maximum error of humidity in the range of 0~80(°C),unit: (%RH)

Note: The above error is the maximum error (excluding hysteresis) of the reference instrument test with a high-precision dew point meter. In the range where the maximum error is $\pm 3\%$ RH, the typical error is $\pm 2\%$ RH, in other ranges, the typical value is 1/2 of the maximum error value.

1.3 Electric Specification

The power consumption given in Table 1 is related to temperature and supply voltage VCC. Estimates of power consumption are shown in Figure 6 and Figure 7. Note that the curves in Figure 6 and 7 are typical of natural and are subject to deviation.

1.4 Electric Specification

In order to meet the needs of different application environments, our company provides AF02 filter cap as an optional accessory, which can better protect the sensor. The details are as follows:

Model	Filter cap	Product Features	Product icon
Standard		Standard version	
Protective cover	✓	Waterproof and dustproof, so that the sensor is protected from external pollutants.	

2 Application Information

2.1 Storage conditions and operating instructions

Humidity Sensitivity Level (MSL) is 1, according to IPC/JEDECJ-STD-020 standard, it is recommended to be used within one year after shipment.

Temperature and humidity sensors are not ordinary electronic components and require careful protection, which the user must pay attention to. Prolonged exposure to high concentrations of chemical vapors will cause the sensor's readings to drift. It is therefore recommended that the sensor be stored in its original packaging, including a sealed ESD pocket, and under the following conditions: temperature range 10°C-50°C (0-85°C for a limited time); humidity 20- 60%RH (for sensors without ESD package). For those sensors that have been removed from their original packaging, we recommend storing them in an ESD bag made of PET/AL/CPE metal inside. The anti-static bag.

During production and transport, the sensor should be protected from high concentrations of chemical solvents and prolonged exposure to the elements. Avoid contact with volatile glues, tapes, stickers or volatile packaging materials such as blister packs, foams, etc. The production area should be well ventilated.

2.2 Restoration Processing

As mentioned above, readings can drift if the sensor is exposed to extreme operating conditions or chemical vapors. It can be brought back to calibration by the following treatments.
 Drying: 10 hours at 80-85°C and <5% RH humidity.
 Re-hydration: 12 hours at 20-30°C and 75-85% Rh⁷.

2.3 Temperature Effects

The relative humidity of a gas depends largely on the temperature. Therefore, when measuring humidity, it is necessary to ensure that all sensors measuring the same humidity work at the same temperature. When doing a test, make sure the sensor being tested is at the same temperature as the reference sensor, and then compare the humidity readings.

In addition, when the measurement frequency is too high, the sensor's own temperature will rise and affect the measurement accuracy. AHT21B should not be activated for more than 10% of the measured time to ensure its own temperature rise is less than 0.1°C. It is recommended that the data collection cycle be greater than 1 time/sec.

7:75% RH can be readily generated from saturated NaCl

2.4 Product Application Scenario Design

In terms of product design, the sensor has the following features :
 In order to improve the stability of the system, the following two power supply control schemes are available.

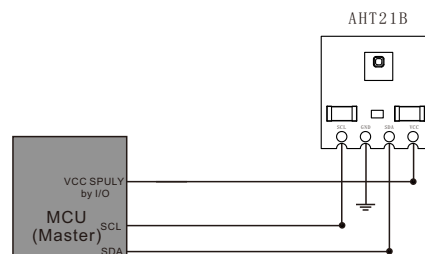

Figure 8-1 Typical Application Circuit 1, the SDA pull-up voltage and VCC are supplied by the MCU.

- Note: 1. the host MCU to AHT21B power supply voltage range of 2.0 ~ 5.5V.
 2. When the AHT21B is just powered on, the MCU will give priority to VCC power supply, and the SCL and SDA can be set high only after 5ms.

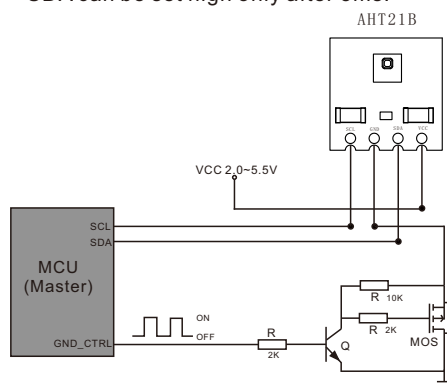

Figure 8-2 Typical Application Circuit 2, AHT21B operation is controlled by whether GND is grounded or not.

- Note: 1. The user can control the GND ground indirectly by controlling the switch module composed of transistor to achieve AHT21B power-down effect.

2.5 Materials used for Sealing and Encapsulation

Many materials absorb moisture and will act as a buffer of color, which can increase response time and hysteresis. Therefore, the materials used around the sensor should be carefully selected. Recommended materials are: Metallic, LCP, POM (Delrin), PEEK, PVDF, PTFE (Teflon), PP, PB, PPS, PSU, PE, PVF materials for sealing and bonding (conservatively recommended): Epoxy-filled or silicone is recommended for the encapsulation of electronic components. Gases from these materials may also contaminate the AHT21B (see 2.2). Therefore, the sensor should be finally assembled and placed in a well-ventilated place or dried at >50°C for 24 hours to allow the release of contaminants before encapsulation.

2.6 Cabling rules and signal integrity

If the SCL and SDA signal lines are parallel and very close to each other, it may cause signal crosstalk and communication failure. The solution is to place VCC/GND between the two signal lines to separate the signal lines. In addition, reducing the SCL frequency can also improve the integrity of signal transmission. Add a 10μF decoupling capacitor to filter between the power pins (VCC, GND).

All of the above have been implemented through the product's own design. Users do not need to change or add additional decoupling capacitors and pull-up resistors. They can be used directly with reference to the classic application circuit.

3 Interface definition

Pins	Name	Description
1	VCC	Supply Voltage
2	SDA	Serial Data, Bidirectional
3	GND	Power ground
4	SCL	Serial Clock, Bidirectional

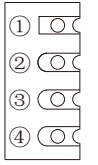

Table 5 AHT21B Distribution of pins (Top View).

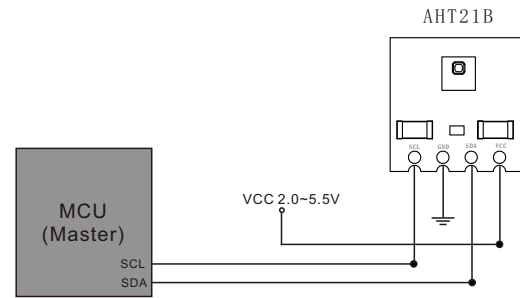

Figure 9 Typical application circuit

- Note:
- 1, the SDA pull-up voltage must be powered by VCC, the supply voltage range is 2.0 ~ 5.5V.
 2. The AHT21B can share the I²C bus with other I²C devices.
 3. During the hot plug test, all interfaces should be disconnected, otherwise it may cause abnormal sensor communication.

valid after the SCL goes low (TV) and remains valid until the falling edge of the next SCL.

In order to avoid signal conflicts, the microprocessor (MCU) must only drive SDA and SCL at low level, and a pull-up resistor is required to pull the signal to high level. The pull-up resistor is included in the internal circuit of the sensor, and the user does not need to Additional additions. Refer to Table 7 and Table 8 for detailed information about sensor input or output characteristics.

4 Electrical characteristics

4.1 Absolute maximum rating

The electrical characteristics of the AHT21B are defined in Table 2. The absolute maximum ratings given in Table 6 are stress ratings only and provide additional information. It is undesirable for the device to be operated functionally under such conditions. Prolonged exposure to the absolute maximum rating may affect the reliability of the sensor.

Parameters	Min	Max	Unit
VCC to GND	- 0.3	5.5	V
Digital I/O Pins (SDA, SCL) to GND	- 0.3	VCC + 0.3	V
Input current per pin	- 10	10	mA

Table 6: Absolute maximum electrical rating

ESD static discharge according to JEDEC JESD22-A114 (human mode ± 4KV), JEDEC JESD22-A115 (machine mode ± 200V). If the test conditions exceed the nominal limits, the sensor requires additional protection circuitry.

3.1 Power pin (VCC, GND)

The power supply range of AHT21B is 2.0-5.5V, and the recommended voltage is 3.3V. VCC is powered on prior to SDA and SCL or is powered on synchronously to avoid leakage current from the signal line (SCL/SDA), which may cause the chip to be in a non-volatile state after power-on. Working status.

3.2 Serial clock SCL

SCL is used to synchronize the communication between the microprocessor and the AHT21B. Since the interface contains completely static logic, there is no minimum SCL frequency.

3.3 Serial data SDA

The SDA pin is used for data input and output of the sensor. The SDA is valid on the rising edge of the serial clock SCL when a command is sent to the sensor and must remain stable when the SCL is high. After the falling edge of the SCL, the SDA value may be changed. When reading data from the sensor, the SDA is

4.2 Input/Output characteristics

Electrical characteristics, such as power consumption, input and output high and low level voltages, depend on the power supply voltage. For smooth sensor communication, it is important to ensure that the signal design is strictly limited to the ranges given in Tables 7, 8 and Figure 17.

parameters	conditions	min	typical	max	unit
Low output voltage VOL	VCC = 3.3 V, -4 mA < IOL < 0mA	0	-	0.4	V
High output voltage VOH		70% VCC	-	VCC	V
Output sink current IOL		-	-	-4	mA
Low output Voltage VIL		0	-	30% VCC	V
High output Voltage VIH		70% VCC	-	VCC	V
Input Current	VCC = 5.5 V, VIN = 0 V to 5.5 V	-	-	±1	uA

Table7 DC characteristics of the digital input and output pads, unless otherwise stated.

VCC =2.0 V to 5.5 V, T = -40 °C to 80 °C。

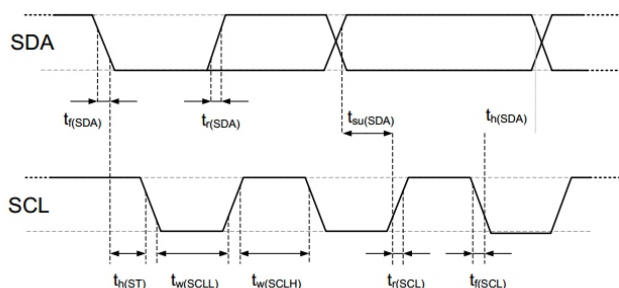

Figure10 :Timing diagram of the digital inputs/outputs abbreviations are explained in Table 8. The thicker SDA lines are controlled by the sensor, while the regular SDA lines are controlled by the microcontroller. Note that the SDA effective read time is triggered by the falling edge of the previous conversion.

Parameters	Mark	I ² C typical model		I ² C High-speed mode		Unit
		MIN	MAX	MIN	MAX	
I2C clock frequency	fSCL	0	100	0	400	KHz
Initial signal time	tHDSTA					μs
SCL Clock High Level Width	tHIGH	4.7		1.3		μs
SCL Clock Low Level Width	tLOW	4.0		0.6		μs
Data setup time vs SCL SDA edge	tHDDAT	0.09	3.45	0.02	0.9	μs
Data save time vs SCL SDA edge	tSUDAT	250		100		μs

Note: Measurements for both pins are from 0.2 VCC and 0.8 VCC.
 Note: The above I2C timing is determined at the following internal delays.
 (1) Internal SDI input pin is delayed relative to the SCK pin, typically 100 ns.
 (2) Internal SDI output pin delay with respect to SCK falling edge, typically 200ns.

Table 8 Timing characteristics of I2C fast mode digital inputs/outputs. The meaning is shown in Figure 17. Unless otherwise noted.

5 Sensor Communication

The AHT21B uses the standard IIC protocol for communication. For information on the IIC protocol other than the following sections, please refer to the following website: www.aosong.com Sample program reference is available.

5.1 Activating the sensor

The first step is to power up the sensor to the selected VCC supply voltage (between 2.0V and 5.5V). After power on, the sensor needs up to 20ms (at this time SCL is high) to reach the idle state that is ready to receive the command sent by the host (MCU).

5.2 Start/Stop Timing

Each transmission sequence begins with a Start state and ends with a Stop state, as shown in Figure 18 and Figure 19.

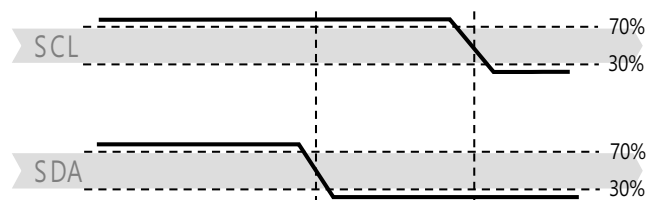

Figure 10: Start Transfer State (S) - When the SCL is high, the SDA switches from high to low. The Start state is a special bus state controlled by the host that indicates the start of a slave transmission (after Start, the BUS is generally considered to be in a busy state)

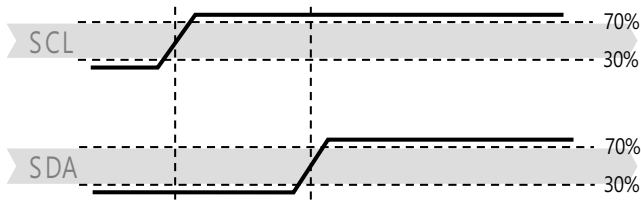
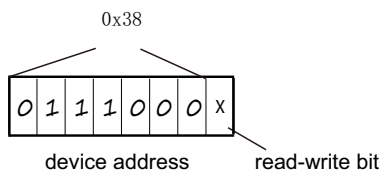

Figure 11: Stop transmission state (P) - When the SCL is high, the SDA line switches from low to high. The Stop state is a special bus state controlled by the host that indicates the end of the slave transmission (after Stop, the BUS bus is generally considered to be idle).

5.3 Sending a command

After initiating the transmission, the subsequently transmitted I2C first byte consists of a 7-bit I2C device address 0x38 and an SDA direction bit x (read R: '1', write W: '0'). After the 8th SCL clock falling edge, the sensor data reception is indicated as normal by pulling down the SDA pin (ACK bit). After issuing the initialization command 0xBE and the measurement command 0xAC, the MCU must wait until the measurement is complete, and the basic commands are outlined in Table 9. Table 10 shows a description of the status bits returned by the slave.



command	definitions	code
Initialization commands	Mainframe	1011'1110 (0xBE)
Trigger measurement	Mainframe	1010'1100 (0xAC)
soft reset		1011'1010 (0xBA)

Table 9: Basic command set

bits	significance	description
Bit[7]	busybody instructions	1- Equipment is busy, in measurement mode 1- Equipment is idle, in hibernation state
Bit[6:5]	retain	retain
Bit[4]	retain	retain
Bit[3]	CAL Enable	1 - calibrated 0--uncalibrated
Bit[2: 0]	retain	retain

Table 10 Description of status bits

5.4 Sensor reading process

1. Wait 40ms after power on, before reading the temperature and humidity values, first of all, see if the calibration enable bit Bit[3] of the status word is 1 (by sending 0x71, you can get a byte of the status word), if it is not 1, send 0xBE command (initialize), this command has two bytes of parameters, the first byte is 0x08, the second byte is 0x00, then wait 10ms.

2. Send 0xAC command (trigger measurement) directly, there are two bytes in this command, the first byte is 0x33, the second byte is 0x00.

3. Wait 80ms for the measurement to be completed, if the read status Bit[7] is 0, it means the measurement is completed, then you can read six bytes continuously; otherwise, continue to wait.

4. After receiving six bytes, the next byte is the CRC check data, which can be read out by the user as required.

$$CRC[7:0] = 1 + x^4 + x^5 + x^8$$

5. Calculate temperature and humidity values.

Note: The calibration status check in the first step only needs to be done at power-up, no operation is required during normal acquisition.

Trigger measurement data

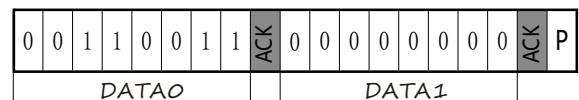
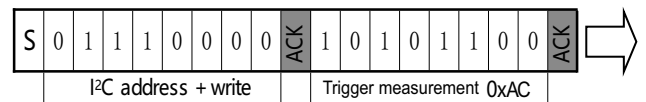

Read temperature and humidity data

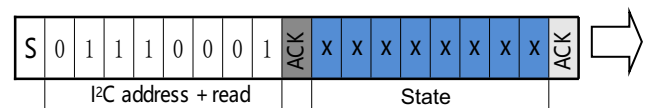

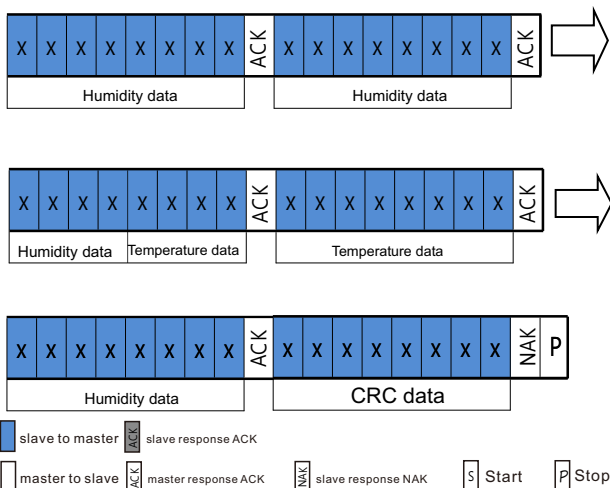

Note: The sensor needs time to collect, after the host sends out the measurement command (0xAC), delay for more than 80 ms to read the converted data and judge whether the returned status bit is normal or not. If the status bit [Bit7] is 0, the data can be read normally, 1, the sensor is busy, the host needs to wait for the completion of data processing.

5.5 Soft Reset

This command (see Table 11) is used to re-initialize the sensor system without having to turn the power off and on again. After receiving this command, the sensor system begins to reinitialize and returns to its default settings, with a soft reset taking no more than 20 milliseconds.

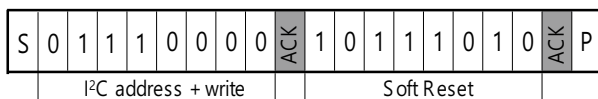

Table 11 Soft Reset - The gray portion is controlled by the AHT21B.

6 Signal Conversion

6.1 Relative Humidity Conversion

Relative Humidity RH can all be based on the relative humidity output from the SDA.

The signal S_{RH} is calculated by the following formula (Results are expressed as %RH):

$$RH[\%] = \left(\frac{S_{RH}}{2^{20}} \right) * 100\%$$

6.2 Temperature Conversion

The temperature T can be set by substituting the temperature output signal S_T into the temperature output signal ST. The following formula gives (Results are expressed as °C)

$$T[^\circ C] = \left(\frac{S_T}{2^{20}} \right) * 200 - 50$$

7 Environmental stability

If the sensor is used in equipment or machinery, make sure that the sensor used for measurement senses the same conditions of temperature and humidity as the sensor used for reference. The AHT21B sensor is tested in accordance with the Aosong corporate standard for temperature and humidity sensors. The performance of the sensor under other test conditions is not guaranteed and cannot be considered as part of the sensor's performance. In particular, no promises are made with respect to the specific conditions required by the user.

8 Package

8.1 Transport Packaging

AHT21B adopts tray packaging, each blister packs 50 sensors, and every ten blister discs are attached with an empty blister disc as a sealing cover, that is, eleven blister discs are sealed in an antistatic shielding bag and packed, A total of 500 sensors.

The packaging diagram with sensor positioning is shown in Figure 12. The blister tray is placed in an anti-static shielding bag.

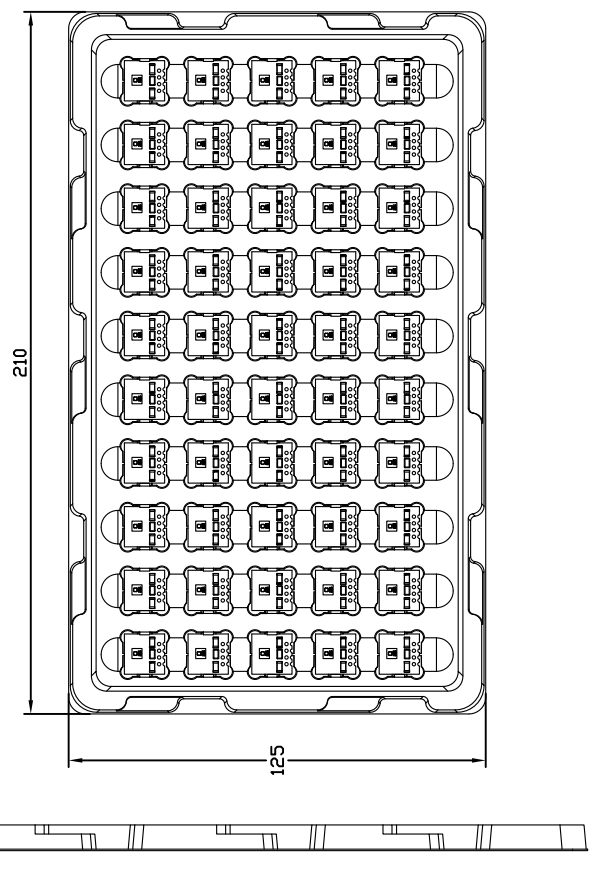

Figure 12 Location map of blister tray and sensor (unit: mm)

8.2 Tracking Information

The anti-static bag or carton has a label, as shown in Figure 13, and provides other tracking information.



Figure 13 Label on anti-static bag

Caveat

Warning, Personal injury.

Do not use this product on safety guards or emergency stop equipment, or in any other application where a malfunction of the product could result in personal injury. Do not apply this product unless specifically intended or authorized for use. Refer to the product data sheet and application guide before installing, handling, using or servicing this product. Failure to follow this advice may result in death and serious personal injury.

If Buyer is to purchase or use an Aosong product without any application license or authorization, Buyer assumes all liability for bodily injury and death arising therefrom and releases Aosong's officers and employees and affiliated subsidiaries, agents, distributors, etc. from any claims that may arise therefrom, including: costs and expenses of any kind, compensation for the use of this product in safety devices or emergency stop equipment. and in any other application where personal injury may result from the failure of this product. Do not use this product unless specifically intended or authorized for use. Refer to the product data sheet and application guide before installing, handling, using or maintaining the product. Failure to follow this advice may result in death and serious bodily injury.

If Buyer is to purchase or use an Aosong product without any application license or authorization, Buyer assumes all liability for bodily injury and death and releases Aosong's officers and employees and its subsidiaries, agents, distributors, etc. from any claims, including costs, damages, attorneys' fees, etc., that may be made against them as a result. Reimbursement costs, attorney's fees, etc.

ESD protection

Due to the inherent design of components, they are sensitive to static electricity. In order to prevent damage from static electricity or to reduce the performance of the product, please take the necessary anti-static measures when using this product.

Quality Assurance

The Company provides a 12-month (1 year) warranty to direct purchasers of its products (calculated from the date of shipment) based on the technical specifications contained in the datasheet published by Aosong for that product. If during the warranty period, the product proves to be defective, the Company will provide a free repair or replacement. The user is required to meet the following conditions:

- 1. the product is notified to the Company in writing within 14 days of discovery of the defect.
- 2. the product defect helps to identify deficiencies in the Company's design, materials and workmanship.
- 3. The product shall be returned to the Company at the purchaser's expense;
- 4. The product shall be within the warranty period.

The company is only responsible for defects in products that have been applied in accordance with the technical conditions of the product. The company makes no warranty, guarantee or written representation as to the use of its products in special applications. The Company makes no warranty as to the reliability of its products or the application of its products in products or circuits.

Copyright© 2020, ASAIR®